



medical
systems



**BLOOD BANK REFRIGERATORS
PLASMA STORAGE FREEZERS
LABORATORY REFRIGERATORS
PHARMACY REFRIGERATORS
LABORATORY FREEZERS
ULTRA LOW FREEZERS**



USER MANUAL

This equipment is certified according to the safety standard IEC 61010-1.

Blood bank refrigerators in 220-240V 50/60Hz, Plasma storage freezers and Ultra low freezers in 230V 50Hz are Class IIa medical devices according to the European Medical Device Regulation (EU) 2017/745 and bear a CE0123 marking.



Blood bank refrigerators in 115-127V 60Hz, Plasma storage freezers and Ultra low freezers in 220V 60Hz and 115-127V 60Hz are Class II medical devices according to 21CFR Part 864.9700 bear a cCSAus marking and are FDA listed.



Laboratory and pharmacy refrigerators in 220-240V 50/60Hz and laboratory freezers in 230V 50Hz are Class I medical devices according to the European Medical Device Regulation (EU) 2017/745 and bear a CE marking.



Laboratory and pharmacy refrigerators in 115-127V 60Hz and laboratory freezers in 220V 60Hz and 115-127V 60Hz are Class I medical devices according to 21CFR Part 862.2050, bear a cCSAus marking and are FDA listed.



This equipment is designed to be safe at least under the following conditions (based on the IEC 61010-1):

- Indoor use;
- Altitude up to 3000 m;
- Temperature 5°C to 40°C;
- Maximum relative humidity 80% for temperatures up to 31°C decreasing linearly to 50% relative humidity at 40°C;
- Mains supply voltage fluctuations up to $\pm 10\%$ of the nominal voltage;
- Transient overvoltages up to the levels of overvoltage category II;
- Temporary overvoltages occurring on the mains supply;
- Pollution degree 2.

TABLE OF CONTENTS

	page
1 Model Overview _____	5
2 Important Information _____	6
2.1 Warnings and Cautions _____	6
2.1.1 Warnings _____	7
2.1.2 Cautions _____	8
2.2 Labels and Symbols on the Packaging _____	9
2.3 Unpacking and Inspection _____	9
2.4 Intended Use _____	10
2.4.1 Intended purpose _____	10
2.4.2 Intended target users _____	11
2.4.3 Intended use environment _____	11
2.4.4 Indications _____	11
2.4.5 Contraindications _____	11
2.5 Operating conditions _____	11
3 Installation Procedure _____	12
3.1 Location _____	12
3.2 Castors _____	13
3.3 Fixation _____	13
3.4 Initial cleaning and disinfection _____	13
3.5 Connection of remote alarm _____	14
3.6 Electrical Connection _____	14
3.7 Network Connection (optional) _____	14
3.8 Electrical protective equipment _____	14
3.8.1 Fuses _____	15
3.8.2 Over-current Release _____	15
4 Use and Operation _____	16
4.1 First start up _____	16
4.2 Important Advice for Storage _____	16
4.3 Switching on/off _____	17
4.4 Opening the door _____	17
4.4.1 Emergency door opening _____	17
4.4.2 Door lock status _____	17
5 Control Panel _____	18
5.1 Overview _____	18
5.2 Display _____	18
5.3 User Login Status _____	19
5.4 Alarm- or Parameter Display _____	19
5.5 Electronic Elements _____	19
5.5.1 Button Functions _____	19
5.5.2 Other Display Elements _____	20
6 Electronics setup _____	21
6.1 Menu structure _____	21
6.2 Parameter change _____	21
6.3 Login / Logout _____	22
6.4 Parameter list _____	22
6.4.1 Setpoints, alarms _____	22
6.4.2 Display _____	23
6.4.3 Language _____	24
6.4.4 Date / Time _____	24
6.4.5 User _____	24
6.4.6 Network _____	24
7 User management _____	25
7.1 User levels _____	25
7.2 User access rights _____	25
7.3 Password change _____	27
7.4 Access cards _____	27

8	Warnings and Alarms	28
8.1	Appearance of Alarm Situations	28
8.2	Alarm Indicators	29
8.3	Alarm Description	30
8.4	Alarm History	31
8.5	Alarm Test	32
8.6	Appearance of Warnings	32
8.7	Description of Warnings	32
8.8	Remote Contact	33
9	Additional Equipment	34
9.1	Rechargeable Battery	34
9.2	USB-port and SD-card-slot	34
9.2.1	USB – Log data	34
9.2.2	USB - Firmware updates	34
9.2.3	SD card slot	34
9.3	Interior Fittings	34
9.4	Safety Thermostat	35
9.5	Fans	35
9.6	Lighting	35
9.7	Gasket Heater	35
9.8	Defrosting	35
9.8.1	B-, L-, P-series	35
9.8.2	F-series	35
9.8.3	U-series	36
9.9	Watercooling	36
9.10	Monitoring accessories	37
9.10.1	Temperature recorder (optional)	37
9.10.1.1	Temperature recorder calibration	38
9.10.2	B Connected	38
9.10.3	Remote temperature monitoring device (RTMD)	38
10	Trends	39
11	Exporting data	40
11.1	How to export data	40
11.2	Exporting messages	41
11.3	Exporting temperature	41
11.4	Exporting logs - BIN	42
12	Service	42
13	System	43
14	Maintenance and Repair	44
14.1	Maintenance	44
14.2	Cleaning	45
14.3	Cleaning the condenser	45
14.4	Removing ice and frost	46
14.5	Replacement of the battery	46
14.6	Repair	47
15	Disposal	47
16	Troubleshooting	48
17	Technical Data	49
17.1	Blood bank refrigerators	49
17.2	Plasma storage freezers	49
17.3	Laboratory and pharmacy refrigerators	50
17.4	Laboratory freezers	50
17.5	Ultra low freezers	51
18	Track change	52

1 Model Overview

Group	Model name
<i>Aircooled units</i>	
Blood Bank Refrigerators	B401 B501 B701 B901
Laboratory Refrigerators	L400 L500 L700 L900
Pharmacy Refrigerators	P400 P500 P700 P900
Plasma Storage Freezers	F401 F501 F701 F901
Laboratory Freezers	F400 F500 F700 F900
Ultra low Freezers	U201 U401 U501 U701 U901
<i>Watercooled units</i>	
Plasma Storage Freezers	F401W F501W F701W F901W
Laboratory Freezers	F400W F500W F700W F900W
Ultra low Freezers	U201W U401W U501W U701W U901W

2 Important Information

- Before using the refrigerator/freezer, read these operating instructions carefully, including all the information on operation, safety, use and maintenance.
- B Medical Systems does not guarantee the safety of the stored products, if the appliance is used for any purposes other than its intended use or if any procedures other than those mentioned in this operating manual are used.
- Keep these operating instructions ready to be check and leave them with the unit, so that all users can be informed on the functions and safety regulations.
- Contact our sales representative or agent for any problems related to these operating instructions.
- Any serious incident that has occurred in relation to the device should be reported to the manufacturer and the competent authority of the Member State in which the user is established.
- These operating instructions may not be reproduced in any form without the written permission of our company.
- Our company guarantees the product under certain warranty conditions. We shall in no way be responsible for any loss or damage of content.
- The sound intensity level produced by the appliance is lower than 70 dBA (measured in a distance of 1 meter).

2.1 Warnings and Cautions

- It is of utmost importance that any user complies with these operating instructions as they contain important safety advice.
- Items and procedures are described so that this unit can be used correctly and safely. Following the advised precautions will prevent possible injury to the user and any other person.
- Precautions are illustrated in the following way:



WARNING

A **WARNING** is a statement that alerts to the possibility of injury, death or other serious adverse reactions associated with the use or misuse of the device.



CAUTION

A **CAUTION** is a statement that alerts to the possibility of a problem with the device associated with its use or misuse. Such problems include device malfunction, device failure, damage to the device or damage to other property.



This mark is placed where electrical components are enclosed to prevent electric shock. The cover should only be removed by a qualified engineer or a service personnel only.





This mark is placed where flammable components (refrigerants) are enclosed. Special care has to be taken when working on these components.



This mark warns about low temperatures and freezing conditions inside the appliance.

2.1.1 Warnings



- Do not use the device outdoors. Current leakage or electric shock may result if the unit is exposed to rain water.
- All installation work and adjustments to the refrigerator or freezer must be carried out by qualified personnel. Work performed by persons with insufficient technical knowledge may adversely affect the performance of the unit or cause physical injury or damage to the equipment.
- Before cleaning or carrying out maintenance work, always switch the device off and disconnect the mains plug. Working on the connected appliance may cause electric shock or fire.
- The wall socket must be easily accessible.
- When disconnecting, always pull the plug and never the cable. Pulling the cord may result in electric shock or fire by short circuit.
- These devices must only be used by adults. Do not allow children to play with it or touch the controls.
- Ensure that the unit is steady and perfectly straight and does not knock against anything next to it. If the floor is not strong enough or the installation site is not adequate, this may result in injury from the unit falling or tipping over.
- When transporting or moving the device, be aware of its weight. Do not try to move a filled appliance.
- The refrigerator/freezer must be fixed to the wall with the chains located at the back side of the unit. A missing or bad wall fixation could result in tipping under certain conditions.
- The unit must be set up in a dry well-ventilated place.
- Ensure that the connecting cable is not squeezed or bent when the unit is being installed or moved. Deterioration of the insulation may cause current leakage or electric shock.
- Never install the device where acid or corrosive gases are present as current leakage or electric shock may result due to corrosion.
- Only connect to a grounded socket. If the power supply outlet is not grounded, it will be necessary to have a ground installed by qualified personnel.
- Before connecting, check whether the details on the nameplate correspond to local values. Use of a voltage or frequency other than that on the nameplate may cause fire or electric shock.
- Do not store flammable or explosive substances inside these appliances (e.g. aerosols with flammable propellant). These may cause explosion or fire. 
- Make sure that no sharp or pointed objects come into contact with the cooling system. The cooling system contains flammable refrigerant. Both the appliance and the products stored inside can be severely damaged if this system starts to leak.
- Do not insert metal objects such as a pin or a wire into any vent, gap or any outlet. This may cause electric shock or injury by accidental contact with moving parts.
- If you are working on the freezers operating below 0°C (F and U-units), be aware that the inside of the unit and the stored products are very cold. Working on the equipment without wearing gloves may result in severe injuries.  
- Before replacing or changing the position of drawers and shelves remove the load first. Removal of loaded drawers and shelves may lead to serious injuries.
- Disconnect the power supply prior to any repair or maintenance in order to prevent electric shock or injury.
- Do not touch any electrical parts (such as power supply plug) or operate switches with a wet hand. This may cause electric shock.
- All servicing and repairs must be carried out by a qualified customer service engineer. Work performed by persons with insufficient technical knowledge may adversely affect the performance or cause physical injury or damage to the equipment.
- Only genuine spare parts may be used. Use of any other parts may affect the performance or cause physical injury or damage to the equipment.
- The loading must never obstruct the air-inlet-openings at the back inner side of the appliance.
- Make sure that the loading does not touch the reference bottle of the display or recorder sensor.
- Do not overload the unit. Shelves have been designed to support a maximum load of 100kg/m².
- Please note the setpoint limitations for the U and F models (ref. Chapter 17) when operating the devices at an ambient temperature of 43°C. Lower setpoints at these ambient operating conditions may lead to premature device failure.
- It is under the sole responsibility of the organization to preselect the required storage temperature depending on the type and purpose of the stored material, taking into consideration the foreseen duration of the storage and the relevant local regulations.

2.1.2 Cautions



- Ensure that there is sufficient room around the unit for air circulation. Please refer to the installation information regarding this point.
- Do not locate the unit below a ceiling fan or right next to air-conditioning equipment.
- The sound intensity level produced by the appliance is lower than 70 dBA (measured in a distance of 1 meter).
- Check whether the appliance has been delivered undamaged. If you find that damage has occurred in transit, immediately contact the delivery service or relevant sales outlet, submitting the delivery note or proof of purchase. Do not operate a unit that has been damaged in transit! If you are unsure, contact your sales outlet and ask them.
- Follow the instructions for transport and storage of the product marked on the packaging.
- The device must be transported in an upright position only (maximum inclination 45°).
- The delivered configuration of drawers and shelves has been validated at the factory. Any change to the position or the number of drawers and shelves must be authorized by B Medical Systems. Non validated configurations may cause the unit not to fulfill its intended use. If B Medical Systems has not authorized the change of position or number of drawers and shelves, B Medical Systems will not be liable for any possible issues related to the performance and safe operation of the device.
- All validated configurations, including the position and/or number of drawers and shelves are available upon request. Please contact our sales representative or agent.
- Document any change of configuration and report it to Technical Support.
- To ensure that the device is operated under approved conditions, B Medical Systems highly recommends that the user follows an IQ/OQ procedure.
- In case the user decides to change the position and/or number of drawers and shelves without prior authorization from B Medical Systems, please assure that the air circulation inside the chamber is guaranteed in empty and loaded conditions. Restriction of the air circulation may cause the unit not to fulfill its intended use. It is recommended that the user validate the device with the changed configuration before operation.
- All connected devices/signal equipment must be providing reinforced or double insulation for protection against electric shock.
- Upon the occurrence of an alarm situation, attempts must be made to discover the reason for the alarm and resolve it as quickly as possible. If that is not successful the necessary measures must immediately be taken so that the stored goods are not damaged.
- At the first starting up it may happen that the message „BATTERY FAULT“ appears. The message will disappear as soon as the battery is charged.
- Before being loaded, the unit must have reached the set point temperature.
- The loading should only be stored in the provided drawers or racks and should not exceed the the storage areas.
- The user must perform a positive assesment of the displayed temperature when extracting the products from the device, in order to verify that the products have been stored inside the specified temperature.
- The loading must never obstruct the air-inlet-openings at the back inner side of the cabinet.
- Make sure that the blood or plasma bags and/or medical preparations do not tilt to the backside.
- Make sure that the load does not touch the reference bottle of the display or recorder sensor.
- Do not store warm items in the devices. They are not designed for fast cooling of warm items.
- Do not overload the unit. Shelves and drawers have been designed to support a maximal load of 100 kg/m².
- Avoid long door openings to prevent that the inner temperature rises to high.
- Make sure that the door closes correctly and that the door gasket seals correctly against the container.
- In instances where no user is physically present in proximity of the device to assess alarm messages, the remote contact supplied or any other customer independent remote monitoring system shall be used.

Important information for water cooled appliances (optional):





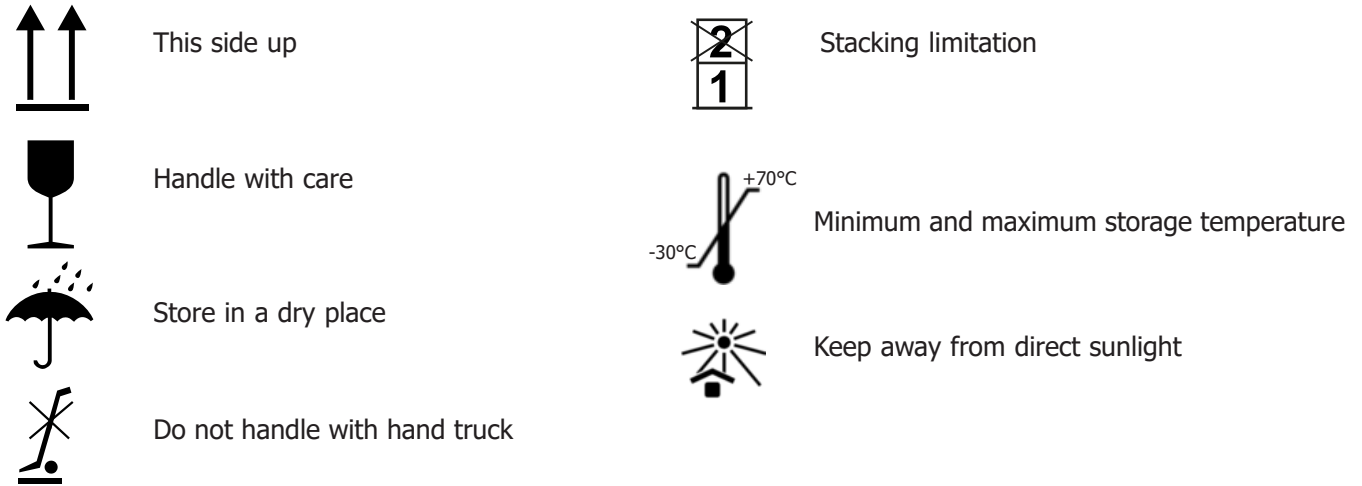

- Water cooled appliances must not be connected directly to the drinking water supply, but only to an separate closed cooling water circuit. During operation the equipment must be continuously connected to the water inlet. Water supply is regulated automatically; if the unit is switched off, no water is used.
- The pressure difference between water supply and return must be at least 2.5 bar but the pressure of the cooling water supply must not exceed 6 bar. The temperature of cooling water inlet must be between 5°C and 15°C.

2.2 Labels and Symbols on the Packaging

- Follow the instructions for transport and storage of the product marked on the packaging:

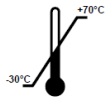

- Please note the following is an example of the B401 packaging label.

REF		UDI	
991.8200.44		 (01)05450104537189 (11)210824 (21)0000000 (240)991.8200.44 (22)B401 (10)ORDERNR001	
			
SN	Order Nr.		Qty
0000000	 ORDERNR 001	Date of manufacture 2021-08-24	1
Product type / Model Blood Bank Refrigerator B401		manufactured by : B medical systems B Medical Systems S.à.r.l. Op der Hei, 17 L - 9809 Hosingen country of origin : LUXEMBOURG	
white 220-240V 50/60Hz		  0123	

2.3 Unpacking and Inspection



CAUTION

- Check whether the unit has been delivered undamaged. If you find that damage has occurred in transit, immediately contact the delivery service or relevant sales outlet, submitting the delivery note or proof of purchase.
- Do not operate a unit that has been damaged in transit! If you are unsure, contact your sales outlet and ask them.
- The unit must be transported in an upright position only (maximum allowable inclination 45°).

- Make your contribution to saving the environment. Bear in mind that orderly and proper disposal of packing materials is required. Packaging materials and devices are always recyclable and should be taken for recycling.

- The packing of the U-units is equipped with a tilt- and a shock watch. Please refer to the instruction of these labels on the packaging for further information. If one or both of these watches should be damaged, please contact your sales outlet immediately.



2.4 Intended Use

2.4.1 Intended purpose

Blood bank refrigerators

- Blood bank refrigerators are devices intended to be used in the blood transfusion medicine for the support on the diagnosis, prevention and treatment of diseases or injuries by keeping whole blood or blood components (e.g., blood cells or plasma) at a protective and stable temperature until they are ready for use.
- The devices comprise a compression cooling system and an integrated alarm system that warns against unexpected temperature excursions and power failures, as well as a safety thermostat that protects the products from freezing.

Plasma storage freezers

- Plasma storage freezers are devices intended to be used in the blood transfusion medicine for the support on the diagnosis, prevention and treatment of diseases or injuries by keeping blood plasma or blood components in frozen state at a protective and stable temperature until they are ready for use.
- The devices comprise a compression cooling system and an integrated alarm system that warns against unexpected temperature excursions and power failures.

Ultra low freezers

- Ultralow freezers are devices intended to be used in the blood transfusion medicine, in health centers, hospitals, pharmacies, as well as in diagnostic and research laboratories for the support on the research, diagnosis, prevention and treatment of diseases or injuries by keeping blood components and blood plasma, human cells, tissues, vaccines, or other laboratory samples in frozen state at a protective and stable ultralow temperature.
- The devices comprise a single or double stage compression cooling system and include an integrated alarm system that warns against unexpected temperature excursions and power failures.

Laboratory and pharmacy refrigerators

- Laboratory and pharmacy refrigerators are devices intended to be used in health centers, hospitals, pharmacies, as well as in diagnostic and research laboratories for the support on the therapy and/or prevention of diseases by keeping pharmaceuticals, vaccines, cultures, or other laboratory preparations at a protective and stable temperature in refrigerated state until they are ready for application or use.
- The devices comprise a compression cooling system and an integrated alarm system that warns against unexpected temperature excursions and power failures, as well as a safety thermostat that protects the products from freezing.

Laboratory freezers

- Laboratory freezers are devices intended to be used in health centers, hospitals, pharmacies, as well as in diagnostic and research laboratories for the support on the therapy and/or prevention of diseases by keeping pharmaceuticals, vaccines, cultures, test materials, chemicals, reagents, or other laboratory preparations at a protective and stable temperature in frozen state until they are ready for application or use.
- The devices comprise a compression cooling system and an integrated alarm system that warns against unexpected temperature excursions and power failures.

2.4.2 Intended target users

- Pharmacists, doctors, laboratory staff or other staff that are trained and/or experienced in dealing with whole blood and blood components.
- The devices must be operated by individuals in organizations that have the knowledge of applicable regulations and guidelines on the storage and distribution of the above-mentioned products. The organization must implement and validate procedures for the storage and distribution of those products according to these regulations and guidelines, including the necessary storage temperature and the suitable storage period.
- Service technicians with a recognized license or certificate as required by local authorities for installation, servicing and repair of refrigeration systems and equipment, and properly trained on the refrigerator/freezer models.
- Patients do not come into direct contact with the devices.

2.4.3 Intended use environment

- The refrigerator and freezers are stationary type devices and must not be used outdoors.
- The devices are designed to operate at an ambient temperature between 10°C and 43°C with a maximum relative humidity of 75%. Operation outside these conditions is not validated.
- Additional environmental requirements for a safe operation of the devices are documented in these operating instructions and must be observed.
- The ambient temperature range during transport and storage must be -30°C to +70°C at a humidity level below 95%.

2.4.4 Indications

- Blood bank refrigerators are devices intended for the safe storage of whole blood and blood components used in the clinical medicine for diagnosis, prevention and treatment of diseases or injuries, at a temperature between 2°C to 6°C.
- Plasma storage freezers are devices intended for the safe storage of blood plasma or blood components in frozen state at a temperature below -27°C.
- Ultralow freezers are devices intended for the safe storage of blood components and blood plasma, human cells, tissues, live virus vaccines and other laboratory samples at ultralow temperatures down to -86°C.
- Laboratory and pharmacy refrigerators are devices intended for the safe storage of pharmaceuticals, vaccines, cultures, or other laboratory preparations at refrigerated temperatures between 4°C and 15°C.
- Laboratory freezers are devices intended for the safe storage of pharmaceuticals, vaccines, cultures, test materials, chemicals, reagents, or other laboratory preparations at temperatures below -20°C.



WARNING

- It is under the sole responsibility of the organization to preselect the required storage temperature depending on the type and purpose of the stored material, taking into consideration the foreseen duration of the storage and the relevant local regulations.

2.4.5 Contraindications

- The devices are not intended to be used for quick cooling or freezing of the stored products.
- The devices are not intended to be used for the storage of foodstuffs or any other products not covered in the intended use.
- The devices are not intended to be operated outside the environmental and installation conditions documented in these operating instructions.

2.5 Operating conditions



WARNING

- Please note the setpoint limitations for the U and F models (ref. Chapter 17) when operating the devices at an ambient temperature of 43°C. Lower setpoints at these ambient operating conditions may lead to premature device failure.

3 Installation Procedure



WARNING

- All installation work and adjustments to the refrigerator or freezer must be carried out by qualified personnel. Work performed by persons with insufficient technical knowledge may adversely affect the performance or cause physical injury or damage to the equipment.
- Ensure that the connecting cable is not squeezed or bent when the unit is being installed or moved. Deterioration of the insulation may cause current leakage or electric shock.



CAUTION

- To ensure that the device is operated under approved conditions, B Medical Systems highly recommends that the user follows an IQ/OQ procedure.

3.1 Location

- The following section provides information on how to install and place the device in your location. Please note that all indicated distances are minimum distances.



WARNING

- Do not use the device outdoors. Current leakage or electric shock may result if the unit is exposed to rain water.
- Ensure that the unit is steady and perfectly straight and does not knock against anything next to it. If the floor is not strong enough or the installation site is not adequate, this may result in injury from the unit falling or tipping over.
- Never install the unit where acid or corrosive gases are present as current leakage or electric shock may result due to corrosion.
- The wall socket must be easily accessible.

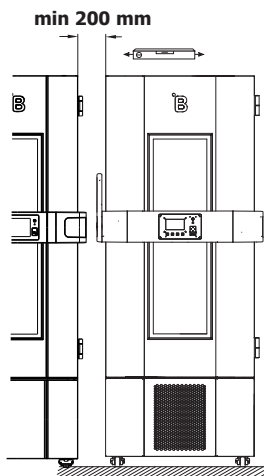

image 1:
minimum distance to other devices

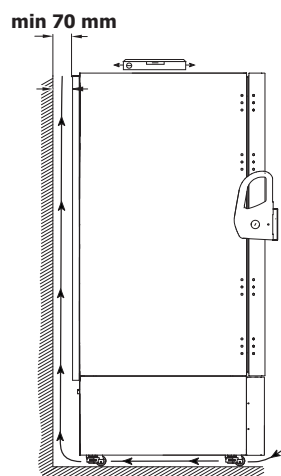

image 2:
minimum distance to the wall

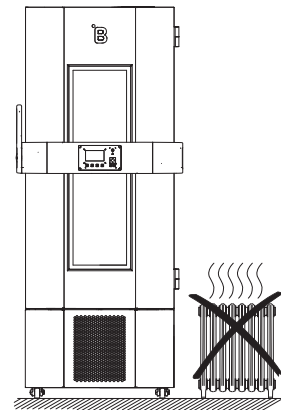

image 3:
avoid placing the device near to any heat source



CAUTION

- Optimal function of the appliance is given at an ambient temperature indicated in the technical data (see chapter 17) with a maximum relative humidity of 75%.
- Ensure that there is sufficient room around the unit for air circulation. Refer to images 1 and 2 for minimum distances to a wall or adjacent units.
- The device must be set up in a dry well-ventilated place. Avoid direct sunlight or locating it close to a heat source (image 3).
- Do not locate the unit below a ceiling fan or right next to air-conditioning equipment.
- This device cannot be used/is not for use in facilities at altitudes of 3000m or higher.

3.2 Castors

- All units are equipped with castors. Once the unit is in its final position, the foot integrated into the castor must be unscrewed in order to immobilize the unit and prevent it from moving. Turn the foot until it is flush with the ground (image 4).

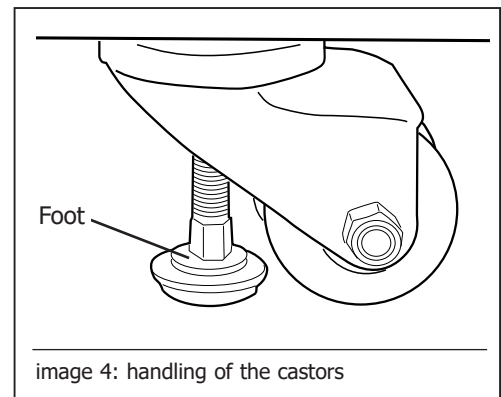

image 4: handling of the castors

3.3 Fixation

- The refrigerator/freezer must be fixed to the wall with the chains located at the back side of the unit.
- A hook, as shown on picture or similar, with a minimum thread diameter of 5mm must be used. The needed wall hooks are not supplied by B Medical Systems.



WARNING

- A missing or bad wall fixation could result in tipping of the unit under certain conditions.

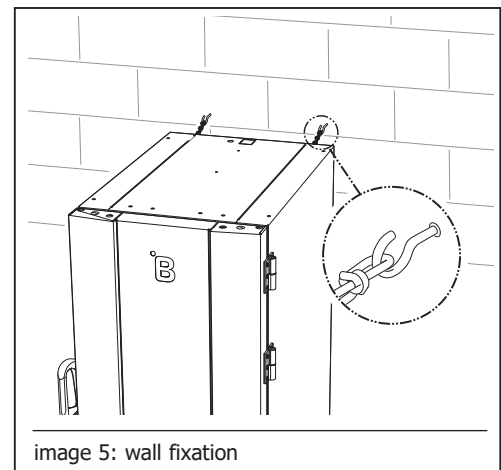

image 5: wall fixation

3.4 Initial cleaning and disinfection



CAUTION

- The use of hydrogen peroxide H₂O₂ (VHP) for the disinfection (sterilization) of the appliances is not suitable. This procedure may be applied exclusively with dedicated appliances.
- Before using the refrigerator or freezer it should be cleaned inside and outside.
- For cleaning, use only gentle cleaning agents. Never use aggressive or caustic cleaning agents, scouring powder, steel wool, abrasive sponges or chemical solvents.
- For disinfecting, we recommend all the surface disinfecting agents commonly used by the customer, provided they are recommended by the national organizations. For disinfecting small areas, we recommend using a concentrated alcoholic agent.
- Refer to section 14 for more information on cleaning.
- Other than the cleaning procedures described in this manual, follow the internal policy and procedures on cleaning, disinfection and maintenance established by your facility.

3.5 Connection of remote alarm

- Connect the remote alarm located on the back of the unit to your surveillance system by respecting the connecting diagram in section 8.8.

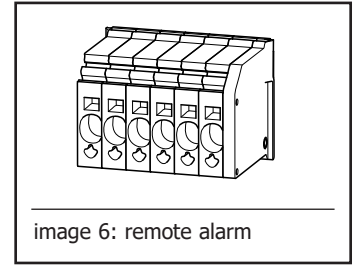

3.6 Electrical Connection



WARNING

- Only connect to a grounded socket. If the power supply outlet is not grounded, it will be necessary to have a ground installed by qualified personnel.
- Before connecting, check whether the details on the nameplate in the interior correspond to local values. Use of any other voltage or frequency other than that on the nameplate may cause fire or electric shock.
- Disconnect the unit from power supply prior to any repair or maintenance in order to prevent electric shock or injury.
- Do not touch any electrical parts (such as power supply plug) or operate switches with a wet hand. This may cause electric shock.
- When disconnecting, always pull the plug and never the cable. Pulling the cord may result in electric shock or fire by short circuit.



CAUTION

- Before connecting and switching the unit on for the first time, allow it to stand for 30 minutes.
- To prevent problems with other electrical equipment causing malfunction, the unit should be connected to a separate circuit. Never connect it to a single socket with other electrical equipment by means of a multi-socket.
- Make sure that the plug is easily accessible so that if needed it can be easily be disconnected without having to move other equipment or furniture.

3.7 Network Connection (optional)

- There is an Ethernet port at the back of the unit. Connect your network cable in this port. Refer to Network configuration chapter for more information.

3.8 Electrical protective equipment

- Depending on the model and voltage, the units are equipped either with fuses or over-current-release. Refer to the table below for detail on your equipment.

Modelseries	Voltage	Fuses	Over-current-release
B-, L-, P-series	all	•	
F-series	230V / 50Hz		•
F-series	220V / 60Hz		•
F-series	115-127V / 60Hz		•
U-series	all		•

3.8.1 Fuses

- Two fuses are located in the fuse housing on the back side of the unit.
- The unit does not work, if one of the fuses has blown.
- In case of a blown fuse, replace it by a new one of the same type and value only. Type and value of the fuse can be found on the label next to the appliance coupler. Try to switch the unit on again. If the problem persists, please inform an electrical specialist or the customer service.

3.8.2 Over-current Release

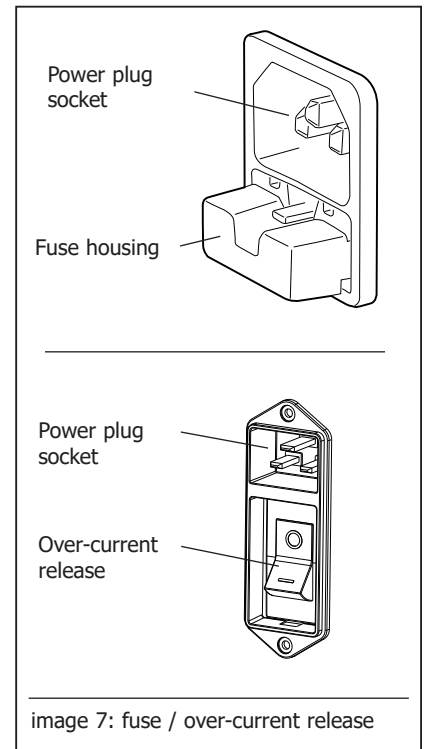

- The circuit breaker is located on the back side of the unit.
- The unit does not work, if the circuit breaker has released or if it has been switched off.
- If the circuit breaker should have tripped, try to switch on again. If the problem persists, please inform an electrical specialist or the customer service.



4 Use and Operation



WARNING

- The devices must only be used by adults. Do not allow children to play with it or touch the controls.
- Do not store flammable or explosive substances inside these appliances (e.g. aerosols with flammable propellant). These may cause explosion or fire.
- Make sure that no sharp or pointed objects come into contact with the cooling system. The cooling system contains flammable refrigerant. Both the appliance and the products stored inside can be severely damaged if this system starts to leak. 
- Do not insert metal objects such as a pin or a wire into any vent, gap or any outlet. This may cause electric shock or injury by accidental contact with moving parts.
- If you are working on the freezers operating below 0°C (F and U-units), be aware that the inside of the unit and the stored products are very cold. Working on the equipment without wearing gloves may result in severe injuries.  

4.1 First start up

- After proper installation, follow the initial setup procedure:
 - Switch on the device (refer to section 4.3)
 - Set up language (refer to section 6.4.3)
 - Set up date and local time (refer to section 6.4.4)
 - Check temperature set point and alarm limits (refer to section 6.4.1)
 - Start an "alarm test" procedure (refer to section 8.5)
 - Set / change the password for the different users (refer to section 7.3)



CAUTION

- At the first starting up it may happen that the message „BATTERY FAULT“ appears. The message will disappear as soon as the battery is charged.

4.2 Important Advice for Storage



CAUTION

- Before being loaded, the unit must have reached the set point temperature.
- The loading should only be stored in the provided drawers or racks and should not exceed the the storage areas.
- The user must perform a positive assesment of the displayed temperature when extracting the products from the device, in order to verify that the products have been stored inside the specified temperature.
- The loading must never obstruct the air-inlet-openings at the back inner side of the cabinet.
- Make sure that the blood or plasma bags and/or medical preparations do not tilt to the backside.
- Make sure that the load does not touch the reference bottle of the display or recorder sensor.
- Do not store warm items in the devices. They are not designed for fast cooling of warm items.
- Do not overload the unit. Shelves and drawers have been designed to support a maximal load of 100 kg/m².
- Avoid long door openings to prevent that the inner temperature rises to high.
- Make sure that the door closes correctly and that the door gasket seals correctly against the container.

4.3 Switching on/off

- To switch on press the ON/OFF button for 1 second. The green LED will light up.
- To switch off the unit, the following steps must be respected:
 - Press the ON/OFF button for 3 seconds.
 - Enter the password (refer to chapter Login/Logout)
- When a switch off procedure is triggered by the user, the unit will automatically unlock the door before powering down.

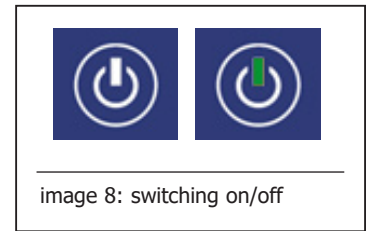

image 8: switching on/off

4.4 Opening the door

- The units are equipped with a one-hand-opening system for the door.
- Before opening the door, push the DOOR LOCK/UNLOCK-button on the interface. Assuming that you are logged in as authorized user, the door will be unlocked and can be opened by means of the opening handle. If you are not logged in, the interface prompts for your login. Refer to the chapter "User management" for more information on this issue.
- When closing the door the handle will automatically slide into the closing latch of the cabinet. Push the handle back in its original position to close the door.
- After closing, the door will be automatically locked after 30 seconds. It can be locked manually by pushing the DOOR LOCK/UNLOCK-button.
- The parameter DOLD which controls the behavior of the door lock can be set to NO in order to avoid that door locks itself automatically (see section 6.4.1).

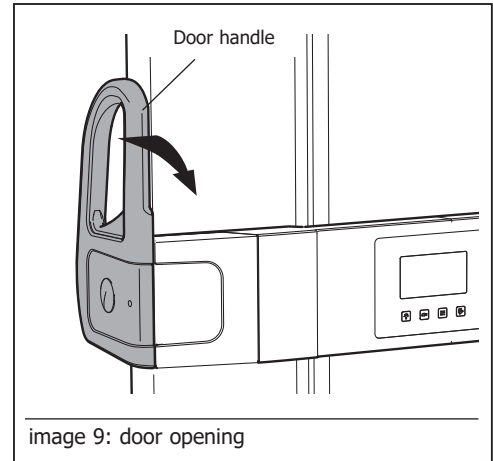

image 9: door opening

4.4.1 Emergency door opening



WARNING

- In case of power failure or malfunction of the display or mainboard, the door cannot be unlocked electronically.

- In such cases it has to be unlocked mechanically:
 - Insert the supplied tool (or any other, but not more than 6mm thick and with a length greater than 25mm) into the small opening in the door handle (image 10).
 - Press carefully to unlock the closing valve.

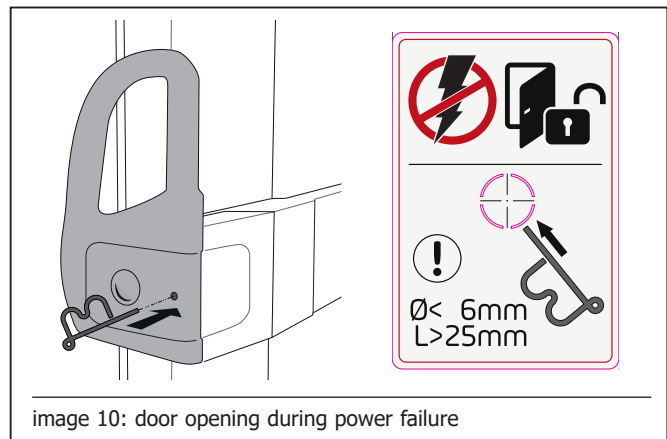

image 10: door opening during power failure

4.4.2 Door lock status

- The status of the door lock is indicated by the corresponding symbol on the display.



door locked



door unlocked

5 Control Panel

5.1 Overview

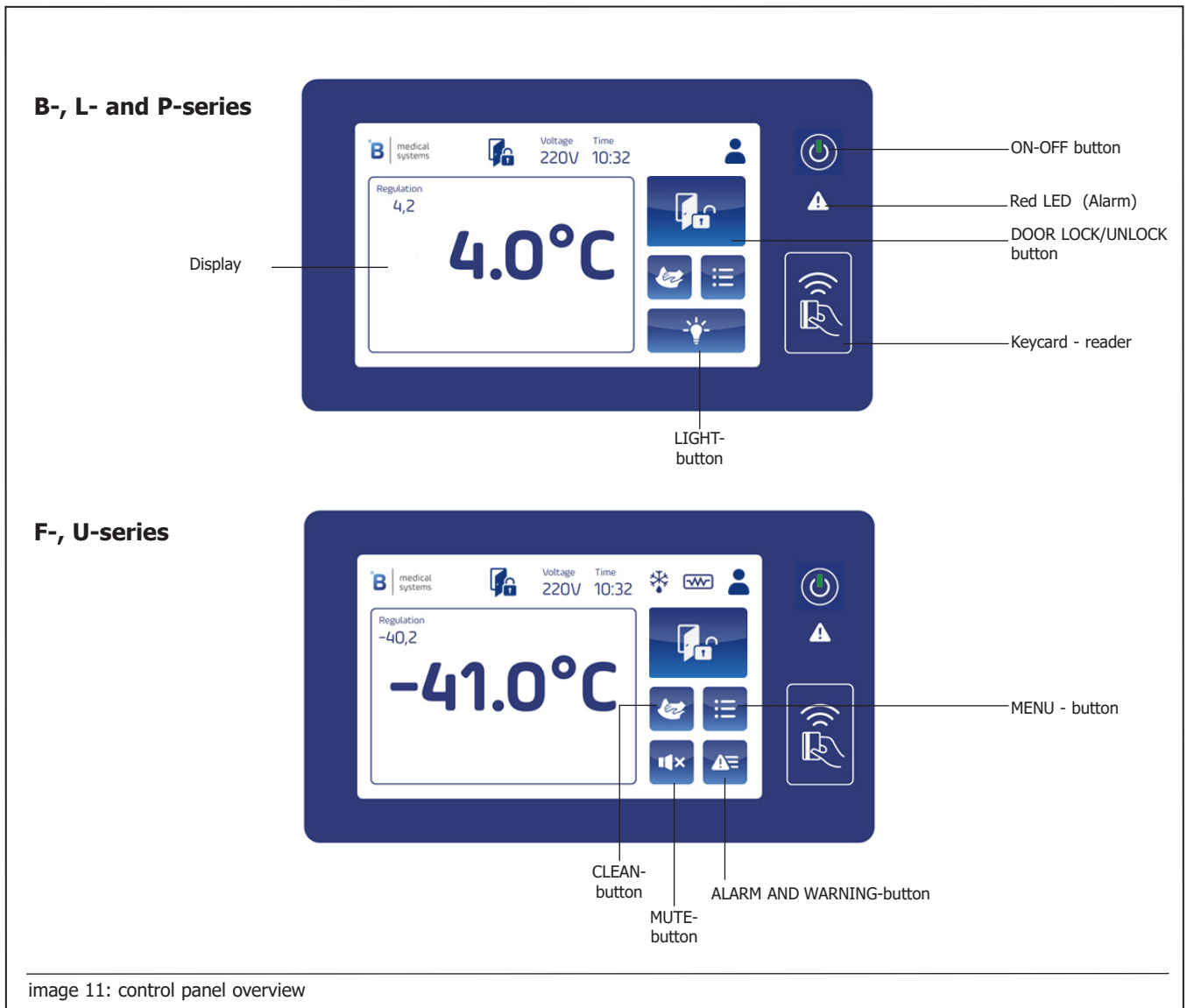

image 11: control panel overview

5.2 Display

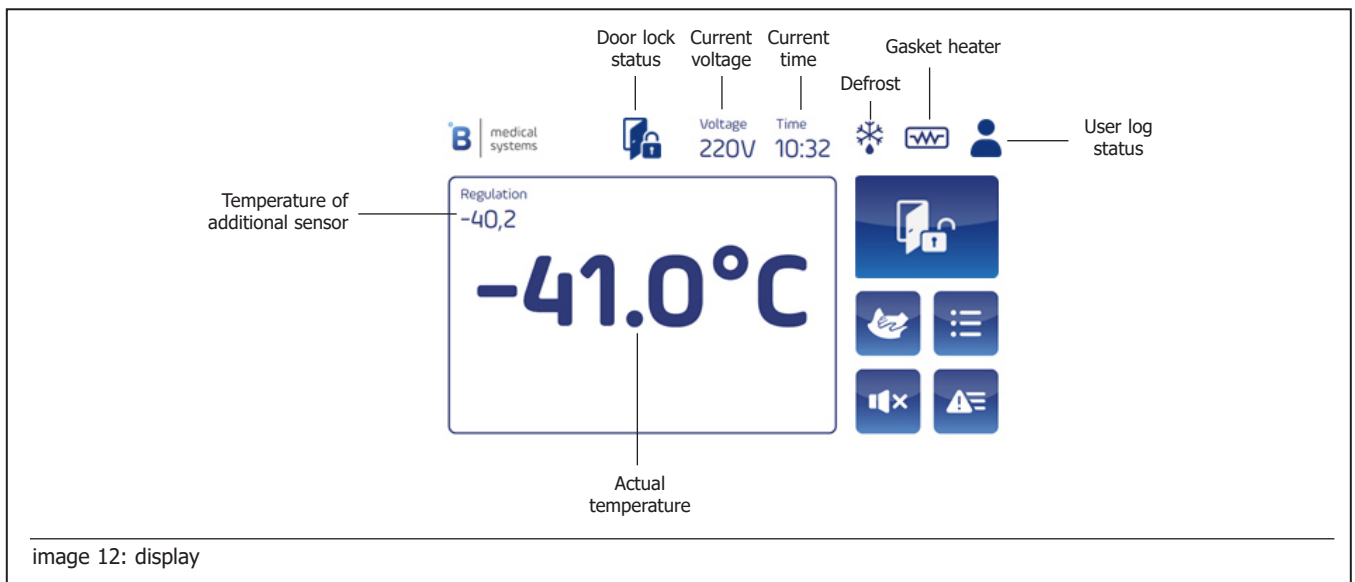
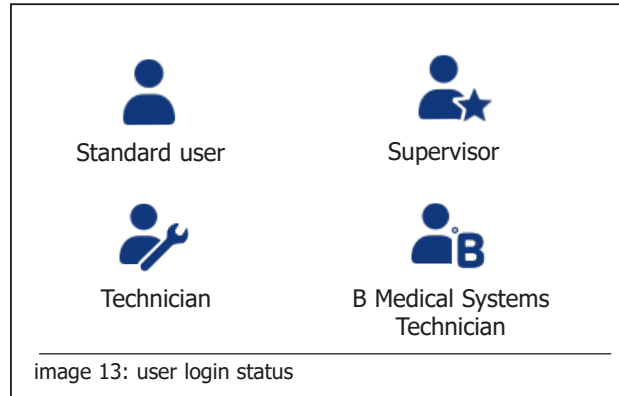

image 12: display

- During normal operation and without a user logged in, the display shows the status of the unit on the main screen.
- The main screen shall show the display temperature in large digits that dominate the screen. The temperature is displayed in Celsius but can be changed to Fahrenheit via the settings menu.
- Additionally, the regulation, evaporator or heat-exchanger temperature can be displayed in the upper left corner of the display. Displaying this temperature can be disabled through the settings.
- The temperature values are displayed with a resolution of 0.1°. Refer to chapter 6.4 for more information.

5.3 User Login Status

- The logged in user level is visible from the lock icon. When a user is logged in, the corresponding symbol appears on the upper right corner of the display.
- If no user is logged in, no symbol is shown.



5.4 Alarm- or Parameter Display

- During alarm situation or in parameter mode, the display will show other information. Please refer to the respective chapters in this manual for additional information.

5.5 Electronic Elements

5.5.1 Button Functions



Door lock/unlock button

This button allows an authenticated user to lock or unlock the door.



Menu button

The menu button allows access to the menu screen.



Cleaning button

The cleaning button allows the user to disable the touch capability of the screen for a short period of time in order to clean the screen.

This button is replaced by the logoff button when any user is logged in.



Alarm and warning history

The "alarm and warning history" button allows a quick access to the active alarm and warning history.



Mute button

The mute button is visible on the main screen only. The button is only usable when an acoustic alarm is active.



Light

The light button allows the switch on or off the interior lighting without opening the door of the refrigerator.



Log off

The log off button allows the user to log off from their current session.

5.5.2 Other Display Elements

Current time

The local time is displayed in hours and minutes, no seconds.

Voltage

Display mains power supply voltage, when selected. The selection is made on the screen for display parameters.

Gasket heater (F- and U-series)

The gasket heater symbol indicates that the gasket heater is activated. If the gasket heater is not switched on the symbol is not visible.

Defrosting (F-series)

The defrost symbol is displayed on the main screen during defrost process.

6 Electronics setup

6.1 Menu structure

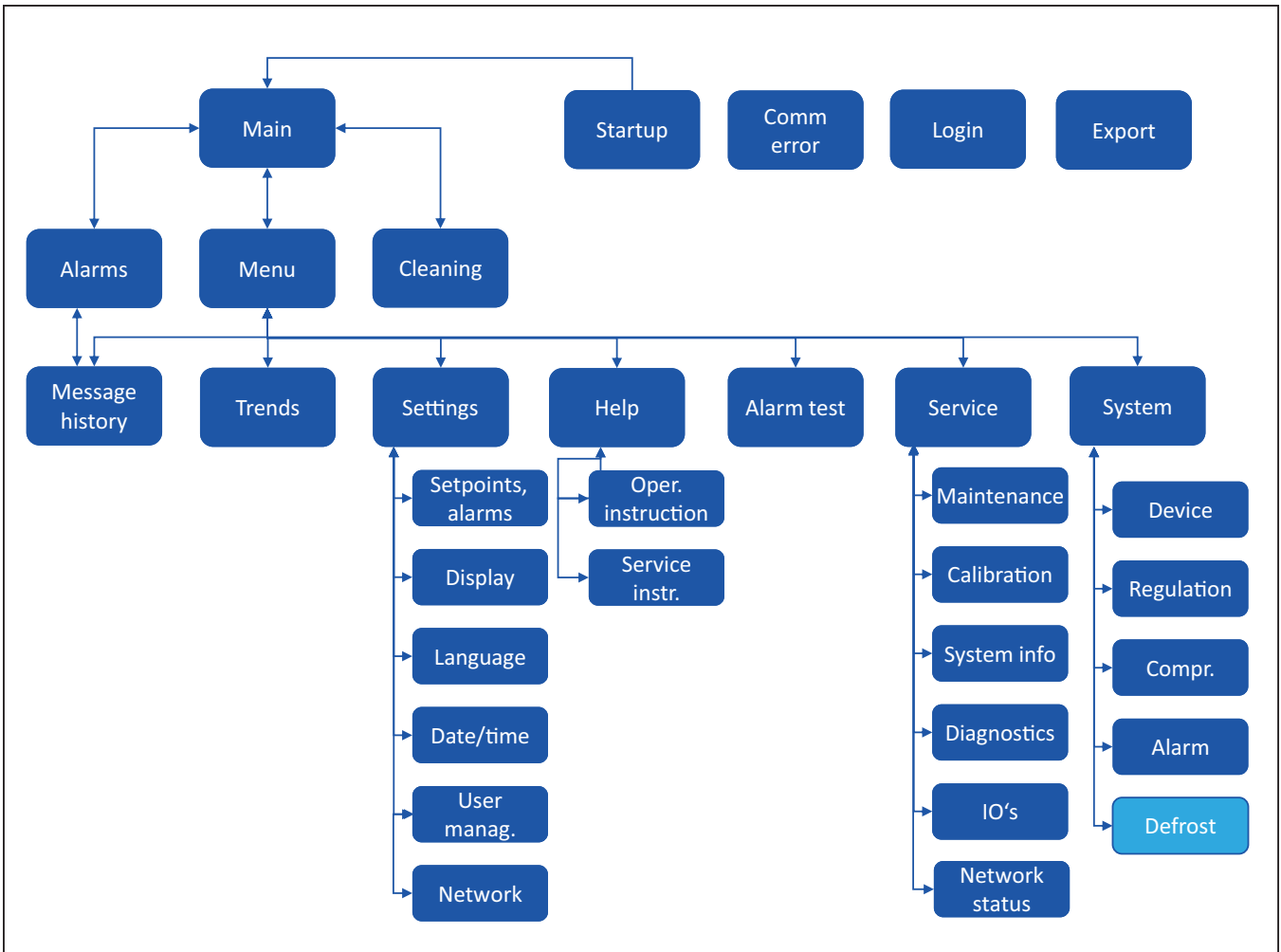

image 14: menu structure

defrost only for F-series

6.2 Parameter change

- Proceed as follows to make a change to a parameter value:
 - Select the parameter to modify from the list by simple touch.
 - If the current access rights for the parameter are not sufficient, a window will pop up to identify as authorized user.
 - A window will pop up showing the parameter description, the actual parameter value and the limits (if applicable).
 - After modifying the parameter value press the check button to confirm.

6.3 Login / Logout

- Spontaneous login can only be done with keycard.
- Otherwise the login screen pops up when trying to access locked functions. Login by code on screen or by keycard.
- Following sequence is used to enter the user and the password:
 - The user level can be selected from a list.
 - A keyboard with numeric signs is used to enter the password.
 - The confirm button shall be pressed to confirm the password entry.
 - The discard button shall be pressed to cancel the password entry.
 - Close the popup to return to the previous screen.
- Lifetime of the login
 - When pressing the logoff-button on main screen.
 - Automatic return to main screen with logout after a defined delay (DALO) without any user activity.

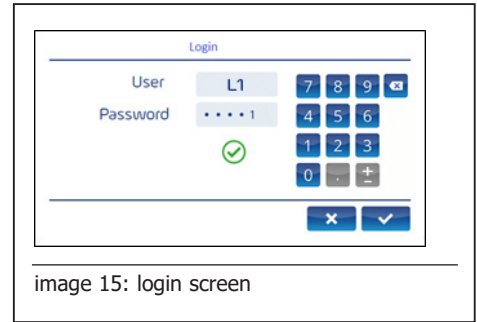

image 15: login screen

6.4 Parameter list

- All major parameters can be accessed by choosing the "Settings" function in the main menu.

6.4.1 Setpoints, alarms

- Use this selection to check the temperature setpoint and the alarm limits.

Parameter	Short description	Range	Unit
SET	Setpoint	depending on model - see technical data	°C
HAL	High temperature alarm	depending on model - see technical data	°C
LAL	Low temperature alarm	depending on model - see technical data	°C
ROD	Remote temperature alarm on open door alarm	Yes / No	n/a
MUD	Muting time acoustic alarm signal	0..30	min
TLI	Temperature log interval	1, 2, 5	Min.
DOLD	Door lock disabled	Yes / No	n/a
LOLD	Logo lighting disabled	Yes / No	n/a
RAR	Remote Alarm Reset	Yes / No	n/a
DT1 *	Defrost time of day 1	00:00..23:59	n/a
DT2 *	Defrost time of day 2	00:00..23:59	n/a
DT3 *	Defrost time of day 3	00:00..23:59	n/a
DT4 *	Defrost time of day 4	00:00..23:59	n/a

* only for F-series

Parameter description :

SET	The temperature set point is the set temperature of the unit. Refer to the technical data of the different models for further information on range and default settings of this parameter.
HAL	The highest admissible internal temperature. If the temperature exceeds this value a temperature alarm is triggered. Refer to the technical data of the different models for further information on range and default settings of this parameter.
LAL	The lowest admissible internal temperature. If the temperature falls below this value a temperature alarm is triggered. Refer to the technical data of the different models for further information on range and default settings of this parameter.
ROD	Remote open door alarm enabled; By setting this parameter to "Y" an open door alarm will be displayed on remote alarm contact "system fail" (see chapter 8.8).
MUD	Duration of mute acoustic alarm signal.
TLI	Defines the time interval for storing the temperature for data export.
DOLD	Setting this parameter to YES will disable the door lock functionality.
LOLD	Setting this parameter to NO will illuminate the „B Medical Systems“-logo in the door.
DT1-4	These parameters are only available for F-models. The procedure of the defrost cycle(s) can be defined with these parameters. See chapter 9.8 for more information on defrosting.

6.4.2 Display

- Use this function to make any adaptation on the display and the buzzer.

Parameter	Short description	Range	Unit
DBO	Display brightness offset	-20, -10, 0, 10, 20	%
DBV	Buzzer volume	20, 40, 60, 80, 100	%
C/F	Temperature unit for display	°C / °F	n/a
DMM	Display mains voltage on main screen	Yes / No	n/a
DDC	Display decimals	Yes / No	n/a
DTAM	Display ambient temperature on main screen	Yes / No	n/a
DTRM	Display regulation temperature on main screen	Yes / No	n/a
DTEM *	Display evaporator temperature on main screen	Yes / No	n/a
DTHM **	Display heat exchanger temperature on main screen	Yes / No	n/a
DTAC	Display ambient temperature in chart	Yes / No	n/a
DTRC	Display regulation temperature in chart	Yes / No	n/a
DTEC *	Display evaporator temperature in chart	Yes / No	n/a
DTHC **	Display heat exchanger temperature in chart	Yes / No	n/a
DBEE	Sound feedback upon touch	Yes / No	n/a
DALO	Auto log-off delay	1..10	min

* only for F-series ** only for U-series

Parameter description :

DBO	Set the brightness of the display
DBV	Set the volume of the alarm buzzer
C/F	Display of the temperature value in °Celsius or in °Fahrenheit.
DMM	Set this parameter to YES to display the value of the mains voltage on the main screen
DDC	Defines if the temperature values on the screen are displayed with or without decimals
DTAM	Provided that an ambient temperature sensor is installed, set this parameter to YES to display the value of this sensor on the main screen
DTRM	Set this parameter to YES to display the value of the regulation temperature on the main screen.
DTEM	For F-units set this parameter to YES to display the value of the evaporator temperature on main screen.
DTHM	For U-units set this parameter to YES to display the value of the heat exchanger temperature on main screen.
DTAC	Provided that an ambient temperature sensor is installed, set this parameter to YES to display the ambient temperature in the chart (see chapter 10).
DTRC	Set this parameter to YES to display the regulation temperature in the chart (see chapter 10).
DTEC	Set this parameter to YES to display the evaporator temperature in the chart (see chapter 10).
DTHC	Set this parameter to YES to display the heat exchanger temperature in the chart (see chapter 10).
DBEE	Setting this parameter to YES will generate a beep for every touch of the buttons or the touchscreen.
DALO	The user will automatically be logged off after the preset time.

6.4.3 Language

- Select "Settings - Language" to adapt the language of all menus to your desired language. Scroll down the list, select the desired language and confirm with Enter-key.
- The default language setting from the factory is English.

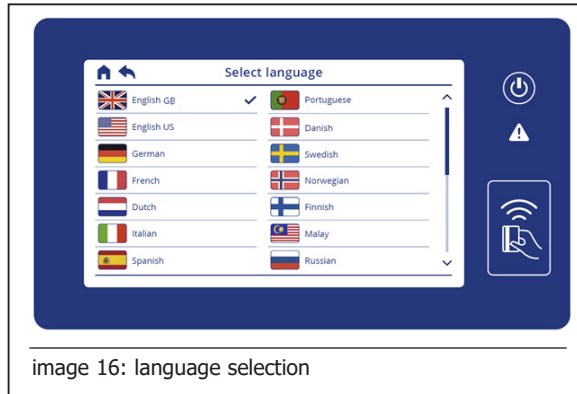

image 16: language selection

6.4.4 Date / Time

- Select "Settings - Date/Time" to adjust date, time and time zone to your local settings.

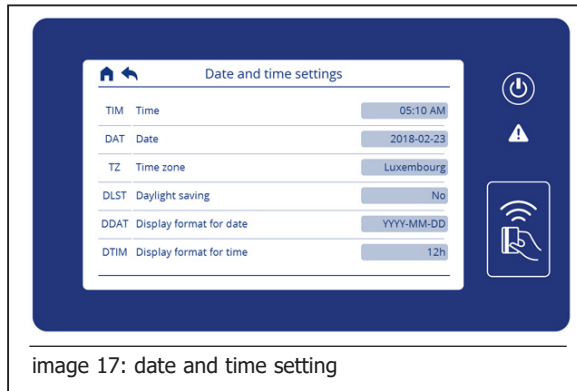

image 17: date and time setting

6.4.5 User

- This function is used to manage the users and access rights for the different functions.
- Refer to chapter "User Management" for further details.

6.4.6 Network





- The network configuration is necessary when connecting the device to the B connected monitoring software.
- The settings must be provided by the local IT administrator.
- Description of the parameters:

Parameter	Description	Range	Default setting
DHCP	DHCP enabled	Yes / No	No
DNAM	Device host name (only when DHCP)	ABCD1234	
DNS1	DNS 1 (only when DHCP)	000.000.000.000	000.000.000.000
DNS2	DNS 2 (only when DHCP)	000.000.000.000	000.000.000.000
DIP	Device IP address (only when no DHCP)	000.000.000.000	192.168.1.1
DSNM	Device subnet mask (only when no DHCP)	000.000.000.000	255.255.0.0
DGAT	Gateway	000.000.000.000	000.000.000.000
MIP	DMN IP address	000.000.000.000	000.000.000.000
MSNM	DMN subnet mask	000.000.000.000	255.255.0.0
MNAM	DMN host name (only when DHCP)	ABCD1234.	SN
MGAT	DMN gateway	000.000.000.000	000.000.000.000

7 User management

7.1 User levels

- Following user levels are available:

	Default (level L0) no login required, no protection
	User (level L1) low-level account for end user, restricted access to user functions. Default password : 00000
	Supervisor (level L2) high-level account for end user, full access to user functions. Default password : 11111
	Technician (level L3) high-level account for °B technician or agent, full access to technician functions
	Engineering (level L5) super-level account for °B production and engineers, full access to all functions

7.2 User access rights

- The supervisor is responsible for the user maintenance and should assign access rights and passwords for all other user levels.
- To modify the user access rights go to Menu, Settings, User management, Access rights. Here you can find the different access rights.
- Table 1 shows the different functions with the respective access rights.

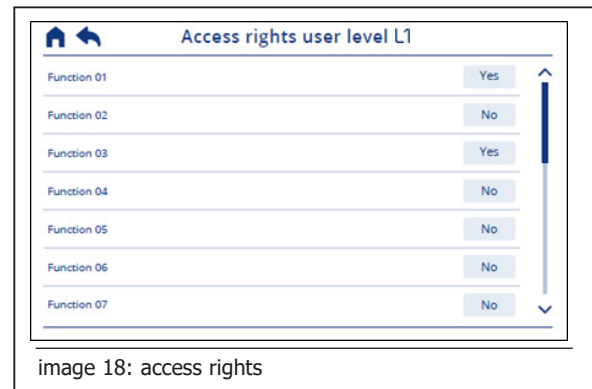

Function	L0	L1	L2	L3	L5	Remark
Open door	◇	●	●	●	●	
Shut down	◇	◇	●	●	●	
Startup	●	●	●	●	●	
Export message history	◇	◇	●	●	●	
Delete message history	◇	◇	●	●	●	
Confirm temperature alarm	◇	◇	●	●	●	
Export temperature charts	◇	◇	●	●	●	
Edit values from "settings – setpoints, alarms"	-	◇	●	●	●	Temp. unit, resolution, brightness
Edit values from "settings – language"	-	◇	●	●	●	For all functions marked with *
Edit values from "settings – date and time"	-	◇	●	●	●	For all functions marked with *
Edit values from "settings – network"	-	-	●	●	●	For all functions marked with *
Manage access cards L1-L2	-	-	●	●	●	Management of authentication by NFC
Manage access cards L3	-	-	-	●	●	Management of authentication by NFC
Manage access cards L5	-	-	-	-	●	Management of authentication by NFC
Modify password L1	-	●	●	●	●	
Modify password L2	-	-	●	●	●	
Start alarm test	-	◇	●	●	●	
Maintenance done button	-	-	Δ	●	●	
Battery replaced button	-	-	Δ	●	●	
Calibrate PT1000	-	-	Δ	●	●	
Export diagnostics	-	-	●	●	●	
Edit System parameters	-	-	-	●	●	Technician, engineering and production
Export BIN data	-	-	●	●	●	
Update firmware	-	-	-	●	●	
Restore parameter set image	-	-	-	●	●	
Switch gasket heater on/off	-	◇	●	●	●	
Start manual defrosting	-	◇	●	●	●	

● access

- no access

◇ can be set by supervisor (L2)

Δ can be set by Technician (L3)

table 1: access rights

7.3 Password change

- To change your own password proceed as follows:
 - Select the user from the list and press Enter. The password-Entry screen appears.
 - Type your new password
 - Repeat the password entry in the line below.
 - Press the - button to confirm the change.

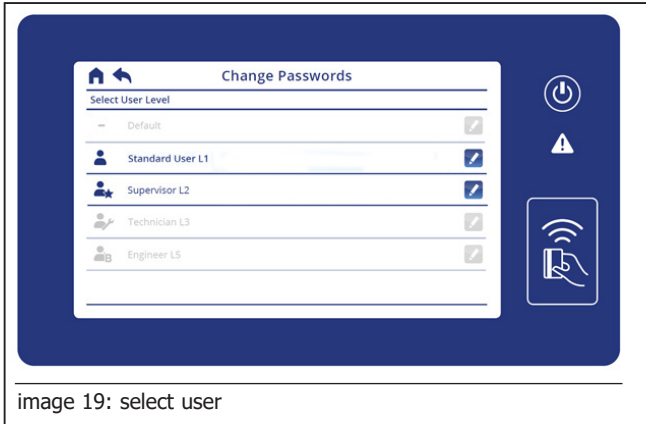

image 19: select user

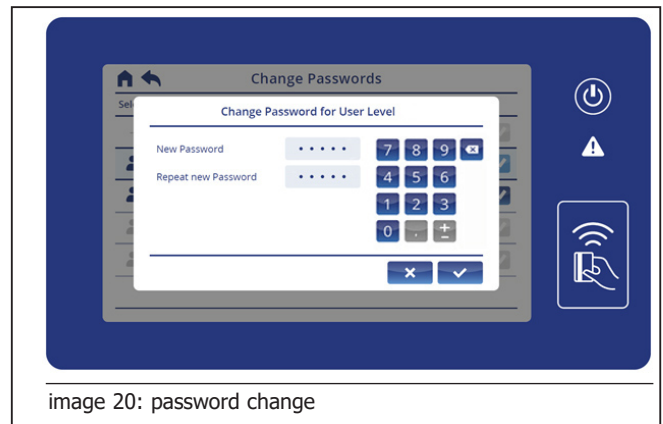

image 20: password change

7.4 Access cards

- Choose the Access cards function in the User submenu.
- User levels L1, L2, L3 and L5 are selectable for editing.
- Upon activation (entire line is active touch area) the following window will open.
- User authentication will be checked individually for the selected access level.
- The antenna recognizes and reads all keycards. The read card id is compared to the existing id's on the active user level. If the card is already in the list, a popup window for deletion shall be opened. If the card is not in the list, a popup window for adding will be opened.

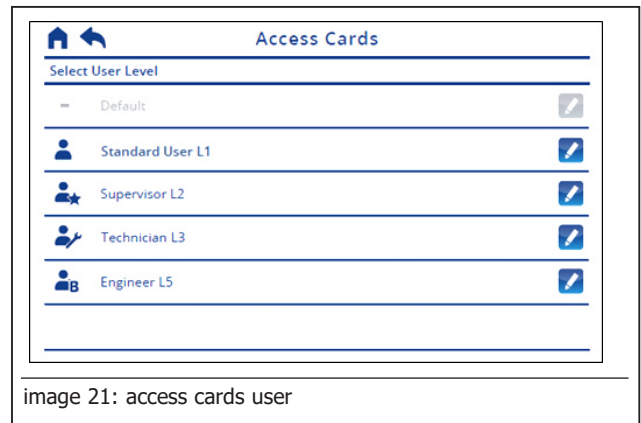

image 21: access cards user

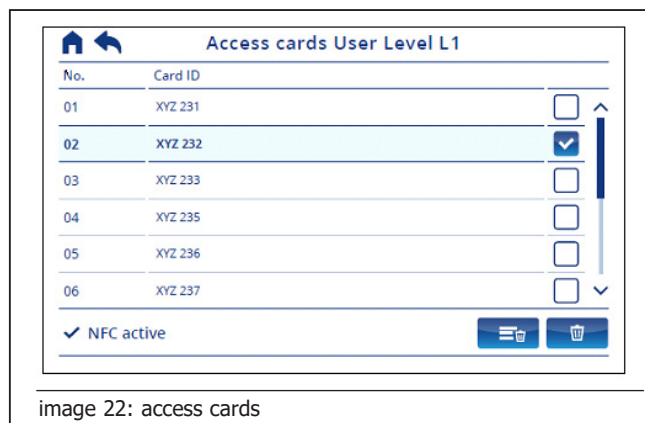

image 22: access cards

8 Warnings and Alarms



CAUTION

- Upon the occurrence of an alarm situation, attempts must be made to discover the reason for the alarm and resolve it as quickly as possible. If that is not successful the necessary measures must immediately be taken so that the stored goods are not damaged.
- In instances where no user is physically present in proximity of the device to assess alarm messages, the remote contact supplied or any other customer independent remote monitoring system shall be used.

8.1 Appearance of Alarm Situations

- Warnings are displayed on the main screen on an orange background.

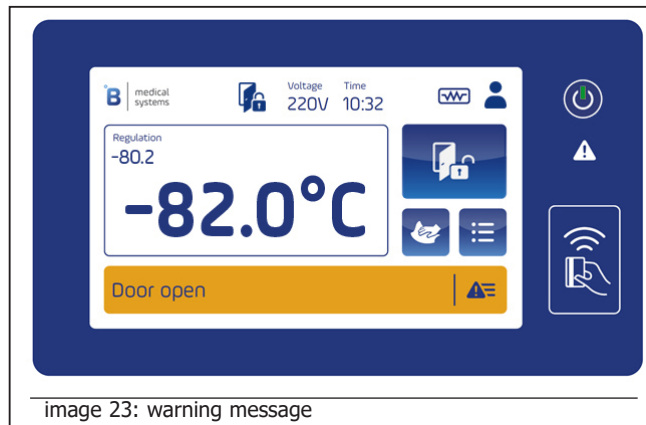



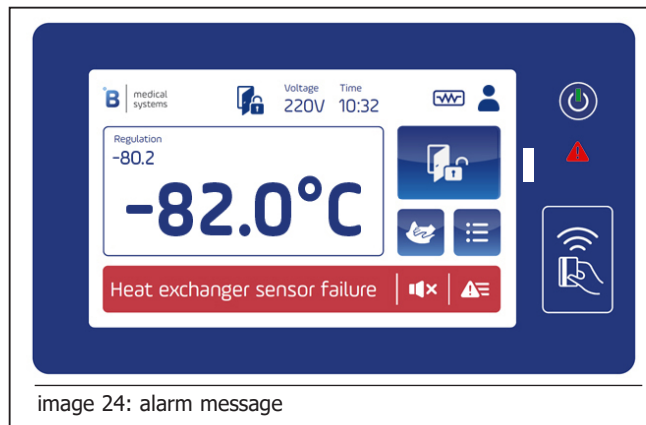





































































- Under an alarm situation, the display will show a message bar with a red background.



- When an alarm occurs, the red LED alarm lights up and an acoustic signal sounds. The corresponding message appears on the display. If several alarms or warnings occur simultaneously, the messages will be shown alternately.
- The buzzer signal can be muted for a predefined time by the user by pressing the Mute-button. If the alarm condition persists beyond this time, the buzzer signal restarts again. If during the Mute-interval another alarm should appear, the buzzer signal restarts immediately. If the buzzer signal is not interrupted by the user, it continues as long as the alarm persists.
- For several alarms (see Alarm-list) the alarm message on the display and the red LED are maintained even after the clearance of the alarm situation until the alarm has been confirmed.
- Active alarms and warnings are accessible via the button "Alarm and warning history" available from the main screen.

8.2 Alarm Indicators

- In case of normal use or in an alarm situation, the indicators such as LEDs and buzzer have different control states. The different states of the indicators are shown in the following table:

Message	Red LED 	Green LED 	Buzzer	Remote contact in alarm situation	temp alarm	system fail	Mute possible	Confirmation necessary
Elementary system faults :								
Communication fault (detected by HMI)				-	-	-	●	-
System fault				(2)	-	-	●	●
Configuration fault				(2)	-	-	●	-
Firmware error				(2)	-	-	●	●
Communication fault to HMI (detected by mainboard)				(1)	-	-	-	●
Temperature alarms :								
High temperature				●	-	-	●	●
Low temperature				●	-	-	●	●
Door open				(1)	-	-	●	-
Confirm alarm				-	-	-	●	-
Temperature sensors :								
Display sensor failure				●	-	-	●	●
Regulation sensor failure				-	-	-	●	-
Evaporator sensor failure *				-	-	-	●	-
Heat exchanger sensor failure **				-	-	-	●	-
System alarms :								
Power fail				-	●	-	-	-
Failsafe running				(2)	-	-	●	●
Battery not connected				-	-	-	●	-
Battery fault				-	-	-	●	-
High voltage				-	(1)	-	●	-
Low voltage				-	(1)	-	●	-
High pressure compr. 1				(2)	-	-	●	-
High pressure compr. 2				(2)	-	-	●	-
RTC				-	-	-	●	-
 LED on  LED flashing  Buzzer on 1s / off 1s  Buzzer off  Buzzer on 0.5s / off 7.5s ● yes - no (1) defined by parameters (2) if temperature monitoring and alarming valid: no. Otherwise: yes. * only for F-series ** only for U-series								
table 2: alarm indicators								

8.3 Alarm Description

Door open alarm

- The door open alarm appears when the door is opened for a time longer than defined by the parameter DAD.
- The alarm disappears as soon as the door is closed again.
- The remote temperature alarm relay is activated when the parameter ROD is set to Yes.

High temperature / low temperature alarm

- The high temperature alarm is triggered when the display temperature exceeds the upper alarm limit given by the parameter HAL.
- The low temperature alarm is triggered when the display temperature falls below the lower alarm limit given by the parameter LAL.
- Both alarm messages disappear as soon as the display temperature is within the alarm limits again.

Display sensor failure

- Failure of the display sensor (measurement fault, not connected, short circuit). As the inside temperature cannot be monitored, this alarm is treated like a temperature alarm.

Regulation sensor failure

- Failure of the regulation sensor (measurement fault, not connected, short circuit). The device operates in failsafe mode, which means that the unit is switching on and off in a predefined cycle.

Evaporator sensor failure (F-series only)

- Failure of the evaporator sensor (measurement fault, not connected, short circuit). The device continues to operate.

Heat exchanger sensor failure (U-series only)

- Failure of the heat exchanger sensor (measurement fault, not connected, short circuit). The device continues to operate.

Power fail alarm

- This alarm message appears with a 10 second delay, if the power supply is interrupted with the appliance switched on.

Battery not connected / battery fault

- This alarm message appears, if there is a problem with the battery. The error cause might be a non-connected or an empty battery.

Communication fault (detected by HMI) / communication fault to HMI (detected by mainboard)

- No communication between mainboard and HMI

High voltage alarm / low voltage alarm

- Voltage is not adapted.

Confirm alarm

- Some alarms need to be confirmed by the user. In such situation, go to alarm history, verify the entries and confirm by pressing the confirm button (check).

Configuration fault

- Configuration fault. No model selected.

System fault

- Electronics fault. The function of the appliance may be affected.

High pressure

- Overpressure detected on the compressor. The high pressure alarm can be considered as high condensing temperature warning, as the condensing pressure is directly linked to the condensing temperature of the unit.

RTC

- Real time clock stopped. Please set date and time.

8.4 Alarm History



- The active alarm screen can be accessed from the main screen by touching the alarm button when an alarm occurs.

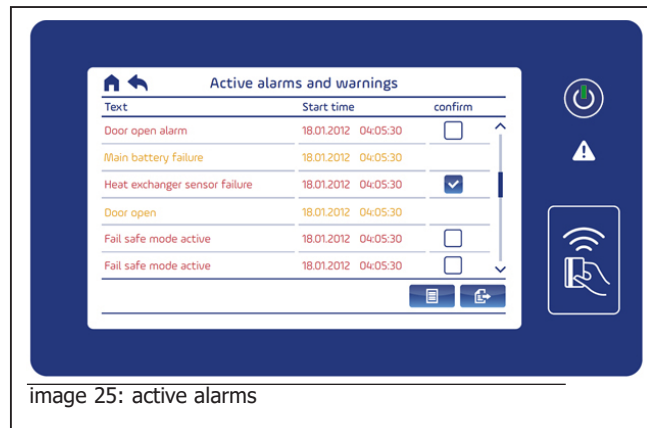

- For a log book of the past alarms, warnings and messages, another history is available through the menu button from the main screen.
- Some filters are available on top of the screen to select only Alarms, Warnings, Events or All. Each message has a description, a start and an end time.
- The button Active Alarm and Warning can be used to show only active alarms and warnings.

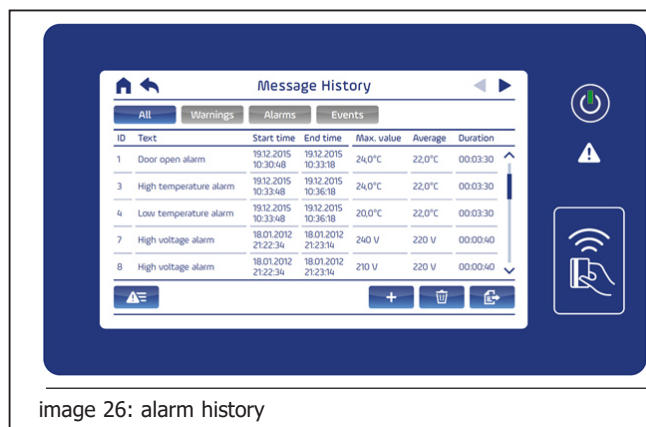

8.5 Alarm Test

- This function allows testing of the different alarm functionalities.
- Choose "Alarm test" from the main menu. The Alarm test screen appears.
- Pressing the Start alarm test - button will initiate an alarm test procedure with the indicated sequence.
- The feature being tested is marked by a blue bullet on the display.
- Pressing the Abort alarm test - key will interrupt the alarm test procedure.
- The function of each alarm output has to be verified. In case of malfunction, technical service has to be contacted immediately.

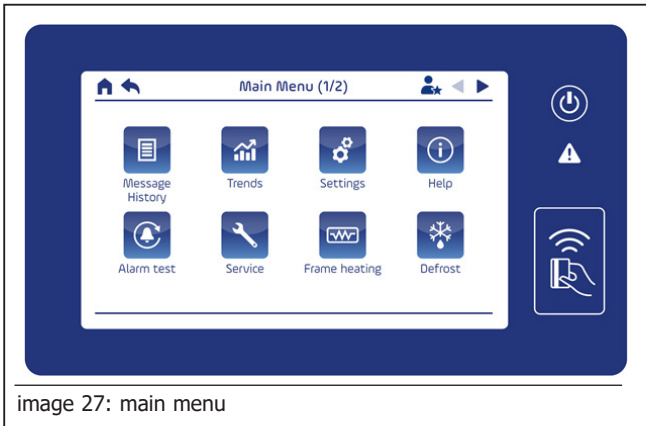

image 27: main menu

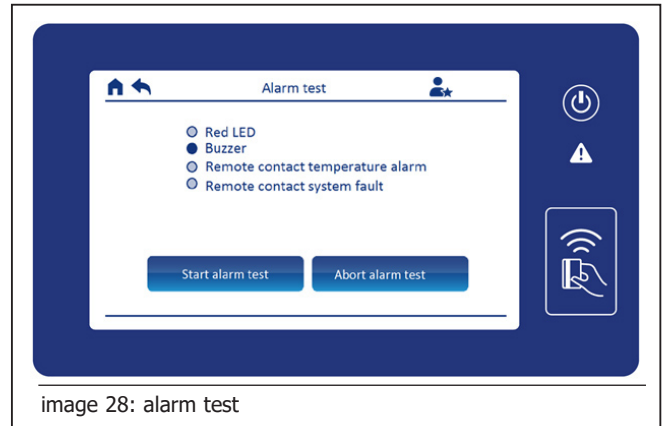

image 28: alarm test

8.6 Appearance of Warnings

- Warnings indicate a situation which may lead to an alarm when no action is taken.
- Whenever warnings lead to an alarm based on an elapsed time, the warning disappears when the alarm is raised.

8.7 Description of Warnings

Door open

- The door open warning appears as soon as the door of the device is opened.

High voltage warning / low voltage warning

- Voltage is too high or too low.

Low battery capacity

- Battery is low

Maintenance required

- Perform the necessary maintenance.

System warning

- Contact service technician

Alarm test running

- Appears during an alarm test. The warning disappears as soon as the test has finished

Temperature alarm disabled

- Appears when the temperature alarm is disabled after switching the device on

High ambient temperature / Low ambient temperature

- Supposed that an ambient sensor is connected, this warning appears if the ambient temperature leaves the permitted temperature range.

Ambient sensor failure

- Failure of the ambient sensor (supposed that this function is activated)

8.8 Remote Contact

- There are two terminals with three potential-free contacts on the back of the unit, that can be used to connect an additional external alarm (visual or audible).
- Contacts 1 - 3 are acting as remote contacts for system faults, contacts 4 - 6 are foreseen for temperature alarms. Refer to the alarm list (8.2) to assign the different alarms to the respective remote contacts.
- During normal operation, contacts 2-3 (5-6) are closed. If an alarm occurs, the electronic will change to contacts 1-2 (4-5). This also applies for when the unit is switched off.
- Connection data :
 - AC : 5V - 250V
 - DC : 5V - 36V
 - max. 6A
 - min. 100mA
- Pressing the MUTE-key in an alarm situation only switches off the internal audible alarm. The key does not interfere with the external alarm. The external alarm signal is only switched off once the cause of the alarm has been eliminated or when the alarm has been confirmed (depending on the RAR parameter - cf. Chapter 6.4.1).

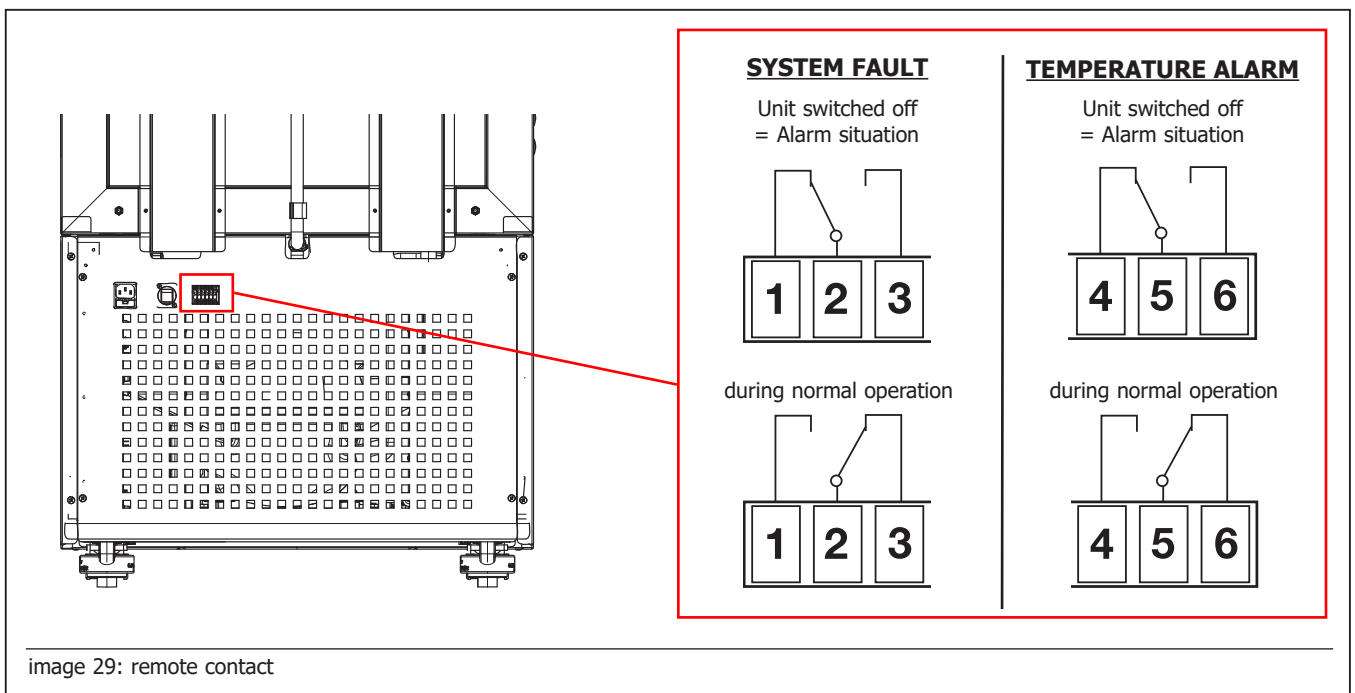

9 Additional Equipment

9.1 Rechargeable Battery

- During an interruption of the power supply, the monitoring and alarm function of the electronics are maintained by an integrated rechargeable battery for at least 48 hours.
- This battery is automatically charged when the appliance is connected to mains.
- If the battery reached its end of life, the warning message "low battery capacity" is displayed.
- The battery should be preventively replaced every 2 years. This replacement must be carried out by a qualified service technician. Before replacing the battery, the appliance must be switched off and the plug pulled out.
- The battery is a lead-acid storage battery that must be disposed of separately in the case of a fault.

9.2 USB-port and SD-card-slot

- USB-ports and SD-card-slot are accessible on the user interface.

9.2.1 USB – Log data

- A USB host interface is available for exporting of log data to USB memory sticks (USB Mass Storage Device). Refer to chapter "Exporting data" for more information.

9.2.2 USB - Firmware updates

- Firmware updates are loadable from the HMI's USB interface.

9.2.3 SD card slot

- A SD-card slot is available for exporting of log data to SD-cards. Refer to chapter "Exporting data" for more information.

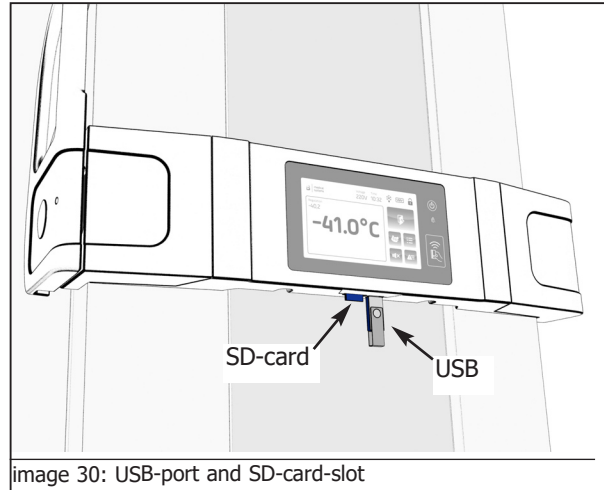

image 30: USB-port and SD-card-slot

9.3 Interior Fittings



WARNING

- Before replacing or changing the position of drawers and shelves remove the load first. Removal of loaded drawers and shelves may lead to serious injuries.



CAUTION

- The delivered configuration of drawers and shelves has been validated at the factory. Any change to the position or the number of drawers and shelves must be authorized by B Medical Systems. Non validated configurations may cause the unit not to fulfill its intended use. If B Medical Systems has not authorized the change of position or number of drawers and shelves, B Medical Systems will not be liable for any possible issues related to the performance and safe operation of the device.
- All validated configurations, including the position and/or number of drawers and shelves are available upon request. Please contact our sales representative or agent.
- Document any change of configuration and report it to Technical Support.
- To ensure that the device is operated under approved conditions, B Medical Systems highly recommends that the user follows an IQ/OQ procedure.
- In case the user decides to change the position and/or number of drawers and shelves without prior authorization from B Medical Systems, please assure that the air circulation inside the chamber is guaranteed in empty and loaded conditions. Restriction of the air circulation may cause the unit not to fulfill its intended use. It is recommended that the user validate the device with the changed configuration before operation.
- The load must be evenly distributed over the drawers or racks.
- Pull out the drawers using the handles only.

9.4 Safety Thermostat

- Refrigerators of the B-, L- and P-series are fitted with a safety thermostat. This thermostat switches off the compressor as soon as the inside temperature falls below +2°C, to prevent the goods being harmed by freezing.

9.5 Fans

- Refrigerators of the B-, L- and P-series and freezers of the F-series are equipped with two interior fans for the air circulation inside the unit. Both fans must work properly to assure a good air temperature distribution.
- To prevent warm outside air being sucked in unnecessarily when the door is open, the fans switch off when the door is opened.
- The airflow to the fans must never be impeded. The ventilation slots must therefore never be blocked or covered.

9.6 Lighting

- Refrigerators of the B-, L- and P-series are equipped with an inner light. The light is turned on with every door opening, but it can also be switched on or off with the appropriate button on the interface.
- The light consists of a long-lasting and maintenance-free LED lamp.
- If the LED should fail, it must be completely replaced. This change may only be done by customer service or by a qualified electrical technician.

9.7 Gasket Heater

- The freezers of the F- and U-series are fitted with a gasket heater. This can optionally be switched on or off via the function "Gasket heater" in the menu.
- The gasket heater symbol on the display shows that the heater is switched on.
- As this heater impairs the freezing performance, it should only be switched on, if condensation appears on the cabinet frame in case of high air humidity.

9.8 Defrosting

9.8.1 B-, L-, P-series

- These units are equipped with finned-tube evaporators which are defrosted after every compressor OFF-cycle (natural defrosting). Under heavy usage conditions, multiple cycles will be needed for a complete defrosting of the evaporator.

9.8.2 F-series

- Freezers of the F-series are fitted with automatic defrosting. A defrost cycle is automatically launched at a preset time of the day. The procedure of a defrost cycle is strictly defined for each model.
- The standard settings foresee one defrost cycle per day.
- Depending on the use of the appliance additional daily defrost phases can be programmed. This change can only be done by a qualified Service technician.
- As the cooling function is switched off during the defrost phase the internal temperature rises. The defrost time is therefore to be set at a time of day when the freezer is not opened.
- During the defrost phase the DEFROSTING-symbol appears on the display.
- The automatic defrosting procedure is not started if no door opening occurred and a given compressor runtime was not reached since the last defrost process.
- The interval between 2 defrost phases must be at least 5 hours.
- A defrost procedure can also be launched manually at any time. To do this select the function "MANUAL DEFROST" in the menu.

9.8.3 U-series



WARNING

- Before cleaning or carrying out maintenance work, always switch the machine off and disconnect the mains plug. Working on the connected appliance may cause electric shock or fire.
- During defrosting, water will leak from the unit. Collect this water so that it does not lead to a risk of slipping for passing persons.
- Defrost water must not penetrate the ventilation slots of the unit.

- Ultra low freezers have to be defrosted manually.
- For optimum performance it is recommended to switch off, defrost and restart the unit at least once a year. In case of heavy duty i.e. frequent daily door openings, repeat this procedure several times a year.

9.9 Watercooling

- If your equipment is provided with a cooling water connection, have this connection installed by a specialist and make sure to follow these advises :
- The pressure of the cooling water at the equipment during operation must be at least 2,5 bar and must not exceed 6 bar.
- The temperature of cooling water inlet should preferably be between 5°C and 15°C.
- It is mandatory to install a water filter in the cooling water circuit.
- The pH value of the water should be between 7 and 9.



CAUTION

- During operation the equipment must be continuously connected to the water inlet. Water supply is regulated automatically; if the unit is switched off, no water is used.
- The connection is made by 3/4" flexible pressure tubing.
- The connections of the cooling water are to be found at the rear side of the unit.
- Water in-and outlet are marked accordingly. Do not interchange! The water supply must be ensured during operation.
- The water outlet must be connected to a sink, drain or recuperation system.
- Control the tightness of the hoses after installation.
- During operation the water filter has to be checked regularly.

9.10 Monitoring accessories

9.10.1 Temperature recorder (optional)

- The recorder is used to record the temperature response over a certain period. The recorder is working with two factory fitted 3.6 volt lithium AA cells which provide a minimum of eighteen months operation.
- The switches and buttons are located on the left side of the recorder behind the temperature chart.
- Initially the recorder period has to be set using the Rotation switch.

Select one of the following settings:

- 8 = shipment setting (factory setting)
- 1 = 12 hours
- 2 = 1 day
- 3 = 7 days
- 4 = 31 days
- 0 = pen alignment
- 9 = pen offset

- The temperature range switch has been set at the factory and there is no need to change it.
- Paper advance :
Pressing and holding the Accept button will advance the chart.

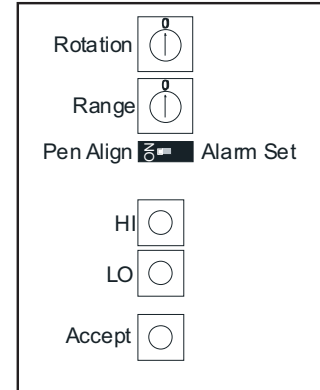

- Changing the chart :

- Lift the pen arm.
- Push the retaining toggle to the open position. Lift the toggle to the upright position. Remove and replace the chart taking care to ensure the chart goes behind the two chart guides. Rotate the chart anti-clockwise until the pen nib is approximately 10mm to the left of the start point. Lock the chart by pushing back the toggle to the lock position. Lower the arm so that the pen nearly touches the chart and use the advance button to align the pen with the start position. Release the pen arm.

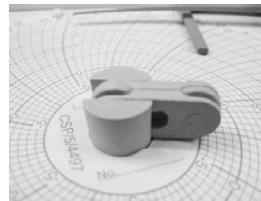

open position



upright position

- Changing the pen :

- Gently lift the pen arm and pull the nib carefully in the arm direction. Take care not to twist the arm on its spindle. Replace with a new pen.

- Replace the batteries :

- Remove the chart as described above. Remove the screws located above and below the chart retainer clip. The batteries must be inserted as indicated on the housing.

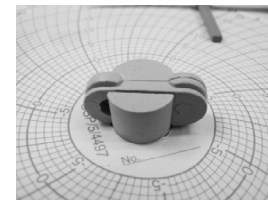

lock position

- Pen alignment :

It is recommended that this procedure is carried out whenever the pen nib is changed or at any time if it is suspected that the pen arm has been forced out of position by rough handling.

- Start with Rotation Switch set to 1
- Set the pen alignment switch to position „ON“
- Set Rotation to 0
- Press HI until the pen is at the outer edge of chart (HI & LO to fine adjust)
- Press ACCEPT (sounds "dit dah" A for Accept)
- Press LO until the pen is at the inner edge of chart (HI & LO to fine adjust)
- Press ACCEPT
- Return the Rotation switch to the required chart speed.
- Set the pen alignment switch to position „OFF“

Note : all modes timeout after 30 seconds of inactivity, if the setting mode is lost then return Rotation SW to 1 then 0 to restart the procedure.

9.10.1.1 Temperature recorder calibration

- The recorder has been calibrated prior to shipment. The frequency of recalibration and the acceptable tolerance may be determined by your organization.
- To adapt the measurements of the calibrated recorder to the temperature of your cabinet, it is important to determine the offset value for your appliance.
- Use a calibrated thermometer to measure the air temperature in the centre of the drawer/shelf placed on the same level as the recorder probe. Compare this temperature to the reading on your chart recorder.
- If there should be a deviation between the reading and the measurement, proceed as follows to adapt the recorder :

Setting a Pen Offset :

- Set the Rotation switch to 1
- Set the pen alignment switch to position „ON“
- Set Rotation to 9 - the pen moves to the unbiased position.
- Press HI or LO until the pen indicates the desired value on the chart.
- Press ACCEPT
- Return the rotation switch to the required chart speed - the pen will now move to indicate temperature with the pen offset.
- Set the pen alignment switch to position „OFF“

Removing a Pen Offset :

- Set the Rotation switch to 1
- Set the pen alignment switch to position „ON“
- Set Rotation to 9 - the pen moves to the unbiased position.
- Press ACCEPT - the offset will be zeroed.
- Return the rotation switch to the required chart speed - the pen will now move to indicate temperature without offset.
- Set the pen alignment switch to position „OFF“

9.10.2 B Connected

- Premium devices are compatible with the B Medical Systems B Connected monitoring software.
- B Connected is a software that retrieves data from the device and sends it to an online platform in order to monitor the connected devices.
- B Connected can also be used to send alarms and warnings to the user remotely, via SMS or email.
- For more information please refer to the B Connected manual or contact your local sales representative.

9.10.3 Remote temperature monitoring device (RTMD)

- Premium devices can be equipped with a remote temperature monitoring device to monitor the temperatures inside the unit, triggering alarms in real-time if the temperature goes outside predefined ranges.
- The RTMD tracks internal and ambient temperatures as well as door openings, and sends the data via GSM to a browser based portal for real time visibility of the performance of the units.
- The Premium U line model is standardly equipped with an RTMD.
- For more information please refer to the RTMD manual or contact your local sales representative.

10 Trends

- The HMI is able to display the temperature charts of the unit.
- In order to display the temperature chart, click on Trends in the Menu.



- The chart displays time stamps on x axis and temperature values on y axis.
- Following trends are displayed in the chart:
 - Display temperature – blue color – always displayed
 - Temperature alarm thresholds low and high – red color – always displayed
 - Regulation temperature – amber color – displayed when configured for displaying (parameter DTRC = yes)
 - Ambient temperature – green color – displayed when present and configured for displaying (parameter DTAC = yes)
 - Heat exchange temperature – violet color – displayed when present and configured for displaying (parameter DTHC = yes)
 - Evaporator temperature – displayed when present and configured for displaying (parameter DTEC = yes)

Chart time span

- The time span is defined by the value selected in the selection box. It can take fixed values:
 - 6 hours
 - 12 hours
 - 1 day
 - 3 days
- When opening the screen, the last selected time span will be used and the end time is set to actual time.

Chart live display

- When the end time corresponds to the actual time, the trend is in live mode. That means it updates its view every time a new value is available.

Y-scale

- The Y-scale of the chart is selectable. It takes fixed values:
 - 6 temperature units
 - 10 temperature units
 - 20 temperature units
 - 50 temperature units
- When opening the screen, the last chosen Y-scale value is applied and the Y-axis is centred on the alarm limit thresholds.

Functionality



Time span selection
Select time span from fixed values.



Scrolling the trend
Move the end time by steps of 1/4 time span.



Move the end time by steps of 1 time span.



Move the Y-axis by steps of 1/4 Y-scale value.



Select Y-span from fix values.



Open the legend
Open a popup screen indicating the trend names and their colors.



Export trends
Go to export screen and mention data type to be exported: temperature data.

11 Exporting data

11.1 How to export data

- Temperatures (CSV), messages (CSV) and logs (BIN) can be exported to a USB storage device or an SD card.
- Exports must be manually triggered by a user.
- USB storage devices and SD cards with FAT32 file system are supported. All files will be stored in the root directory.
- Two file types can be exported:
 - CSV files with history data readable by Excel
 - BIN files with log history data importable into "B connected monitoring software"
- If the door of the appliance must be opened during an export session, the ongoing session must be interrupted to be able to attain the main screen.



CAUTION

- After plugging a USB stick on the dedicated port, the system requires up to 30 seconds to detect it. Don't start the export before, otherwise an error message will appear.

File name

- The export file name will be composed of
 - Device serial number
 - Content type: MSG, TMP or BIN
 - Timestamp of export (local time)
- A typical file name would be "17123456_MSG_YYYYMMDD_hhmmss.csv"

11.2 Exporting messages

Select export data

- Each of the following are selectable with a checkbox:
 - Active alarms and warnings
 - Message history - alarms
 - Message history - warnings
 - Message history - events
- At least one of the above mentioned needs to be selected before starting an export.

Select target

- Selection list: USB or SD-card

Select time span

- Upon export the user must select the time span of data to be exported:
 - last week
 - last month
 - last 3 months

Start export

- Start the export by pressing the button. When the export is started, the system message popup "exporting file" shall appear. When the export is finished, the system message popup will be replaced by the one "Export successful" or "Export failed". When failed, the reason for failure is visible.

Message file content

- The CSV file contains following columns:
 - Message ID
 - Message text in active user language
 - Start time. Format YYYY-MM-DD-hh:mm:ss
 - End time. Format YYYY-MM-DD-hh:mm:ss
 - Duration. Format hh:ss
 - Additional info
- The first line in the CSV file contains the column headers:
MsgId;MsgText;StartTime;EndTime;Duration;AddInfo;

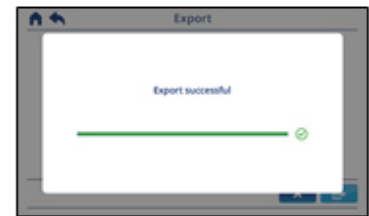

11.3 Exporting temperature

Select time span

- Upon export the user has to select the time span of data to be exported:
 - last week
 - last month
 - last 3 months

Select target

- Selection list: USB or SD-card

Start export

- Start the export by pressing the button. When the export is started, the system message popup "exporting file" shall appear. When the export is finished, the system message popup will be replaced by the one "Export successful" or "Export failed". When failed, the reason for failure is visible.

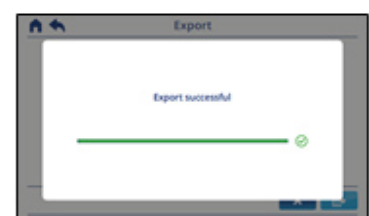
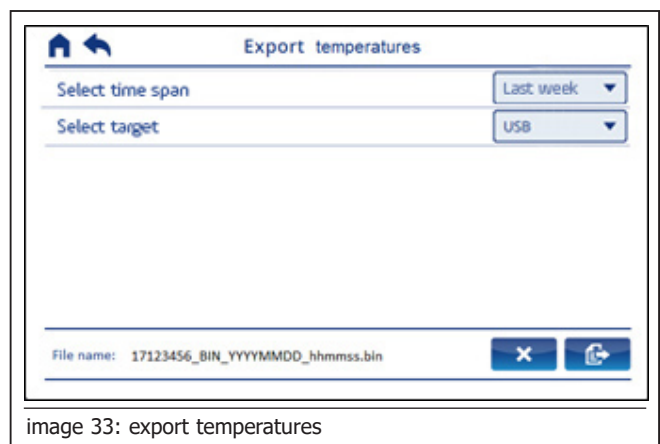

Temperature file content

- When triggering the temperature history, only temperature values are exported.
- The CSV file will contain following columns:
 - Regulation temperature
 - Display temperature
 - Ambient temperature
 - Evaporator temperature
 - Heat exchanger temperature
- The first line in the CSV file will contain the column headers:
TREG[unit];TDIS[unit];TAMB[unit];TEVS[unit];THEX[unit];

11.4 Exporting logs - BIN

Select time span

- The bin file contains data from the long term storage. Upon export the user has to select the time span of data to be exported:
 - last month
 - last 6 months
 - last 12 months
 - device's lifetime

Select target

- Selection list: USB or SD-card

Start export

- Start the export by pressing the button. When the export is started, the system message popup "exporting file" shall appear. When the export is finished, the system message popup will be replaced by the one "Export successful" or "Export failed". When failed, the reason for failure is visible.

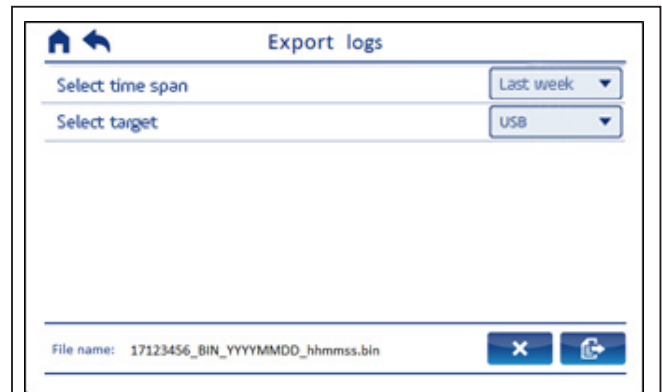
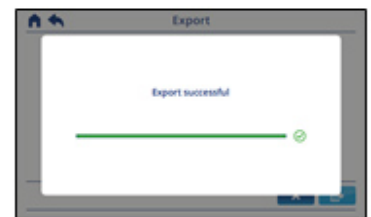

image 34: export logs



12 Service

- The Service menu can be found in the main menu. By clicking on it, you will find the following submenu:
 1. Maintenance screen
 2. Calibration screen
 3. System info screen
 4. Diagnostics screen
 5. IO's screen
 6. Network status screen
 7. Export binaries

Calibration screen

- Screen to calibrate the different sensors.
 - Temperature sensor to calibrate
Input field to select the sensor to display/calibrate. Access to all users.
 - Actual measured value
Input field to enter externally measured temperature value. Authenticated users only.

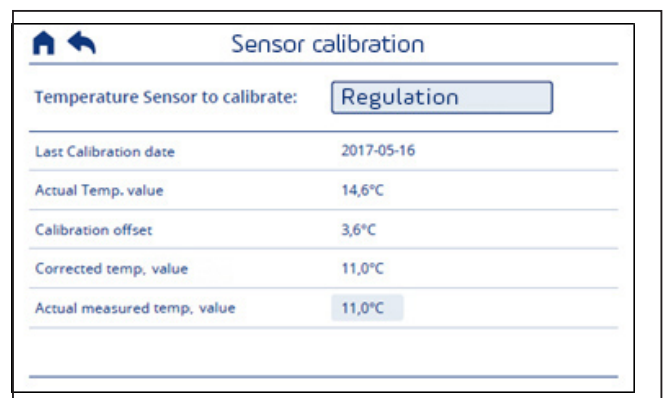

image 35: Calibration



WARNING

- The calibration of the device has to be performed in degrees Celsius (°C). Once this task has been performed, if preferred by the User, the device settings can then be changed back to degrees Fahrenheit (°F).

13 System

- By choosing the System-function on the main screen, you will find the following submenu:
 1. Device parameters screen
 2. Regulation parameters screen
 3. Compressor parameters screen
 4. Alarm parameters screen

Device parameters screen

- Values to show / edit:
 - All device parameters

Regulation parameters screen

- Values to show / edit:
 - All regulation parameters

Compressor parameters screen

- Values to show / edit:
 - All compressor parameters



Alarm parameters screen

- Values to show / edit:
 - All alarm parameters

14 Maintenance and Repair



WARNING

- Before cleaning or carrying out maintenance work, always switch the unit off and disconnect the mains plug. Working on the connected appliance may cause electric shock or fire.
- If you are working on the freezers operating below 0°C (F and U-units), be aware that the inside of the unit and the stored products are very cold. Working on the equipment without wearing gloves may result in severe injuries.  
- All servicing and repairs must be carried out by a B Medical Systems certified and qualified maintenance technician. Work performed by persons with insufficient technical knowledge may adversely affect the performance of the unit or cause physical injury or damage to the equipment.
- Maintenance tasks must be performed on a regular basis as described in the service manual of the product.

14.1 Maintenance

- It is recommended that preventive maintenance be performed at least once a year and must be performed by a B Medical Systems certified and qualified maintenance technician. The maintenance consists of visual, electrical and functional inspections, as well as cleaning and listed below. All technicians should refer to the specific service manual for the unit.
- As the message "maintenance required" is displayed on the user interface, the maintenance tasks from the below table should be performed. Once these have been completed, confirm "Maintenance done" on the user interface (image 36).

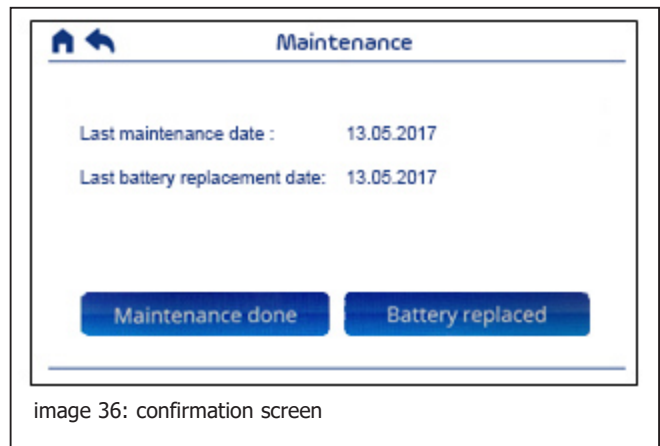

image 36: confirmation screen

Preventive maintenance tasks:

Tasks	Visual Inspection	Functional inspection	Electrical inspection
Mechanical damage	*		
Loading conditions	*		
Ice formation	*		
Condenser	*		
Keycard reader	*		
Sensors	*		
Seals	*		
Functionality user interface		*	
Evaporator fans, lighting and door switch		*	
Condenser fan		*	
Function of heaters		*	
Cooling system temperatures		*	
Alarm test		*	
Door alarm test		*	
Door lock function		*	
Function of drawers and inner doors		*	
Castors		*	
Chart recorder		*	
Air temperature		*	
Door hinges		*	
Mains supply voltage			*
Cord relief			*
Batteries			*
Electrical safety test			*
Cleaning and disinfection	Refer to specific chapter		

14.2 Cleaning

- The unit should be cleaned and if necessary disinfected before you use it for the first time and then at regular intervals thereafter.
- Only use gentle cleaning agents. Never use aggressive or caustic cleaning agents, scouring powder, steel wool, abrasive sponges or chemical solvents. When cleaning, make sure that no fluids of any kind run into the ventilation housing.
- The use of hydrogen peroxide H₂O₂ (VHP) for the disinfection (sterilization) of the units is not suitable. This procedure may be applied exclusively with dedicated appliances.
- Before restarting the unit after cleaning, the interior must be thoroughly dried.

14.3 Cleaning the condenser

- Dust must be removed regularly from the condenser in the machine compartment with the aid of a handbrush or a vacuum cleaner.
 - Remove the condenser cover by pulling the top of the cover (image 37)
 - Use a vacuum cleaner with hose and brush attachments to clean the front face of the condenser, the filter and the grid (image 39). Remove the filter to clean it.
 - Clean up any loose dust. Replace the filter and the grid.
 - Reconnect the power.

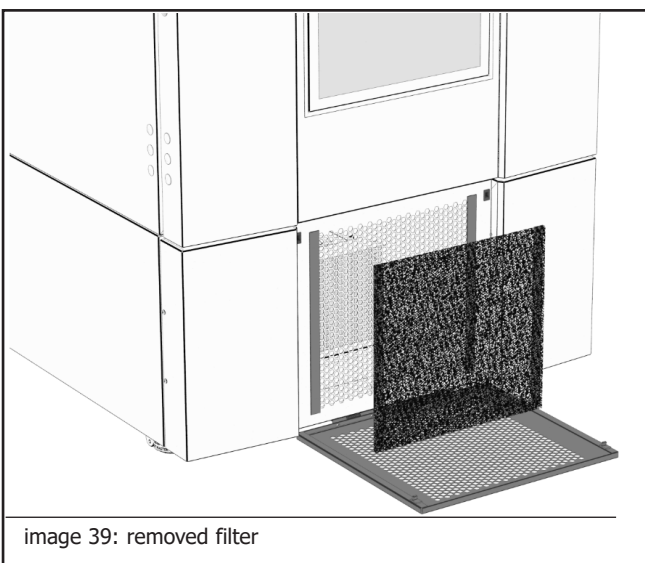
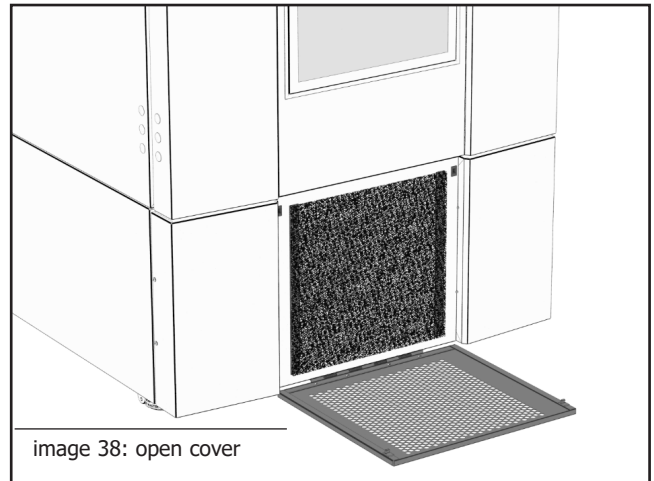
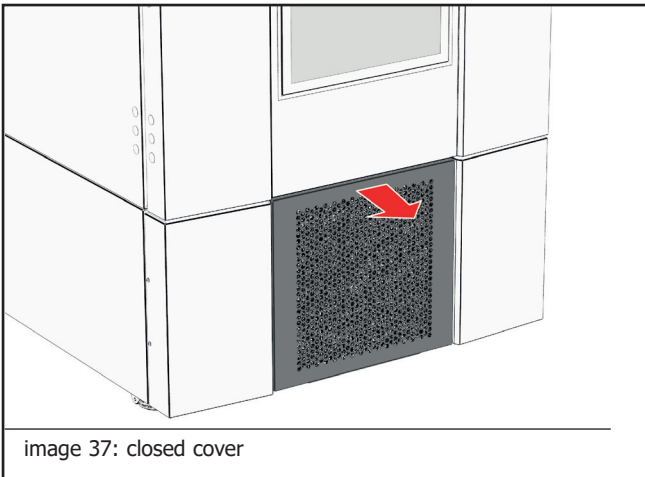

14.4 Removing ice and frost



CAUTION

- Excessive door openings may cause ice and frost build-up in the U and F freezer models.
- U models are equipped with two vacuum release valves on the doors to allow for a quick pressure equalisation after door openings (image 40). Ice and frost build-up around the valve ports may impede the air flow and impact its functionality.

Regularly remove any ice and frost from the inner doors, chamber, gaskets, fan grids and vacuum release valve ports. This will maintain the freezers at an optimal level of performance.

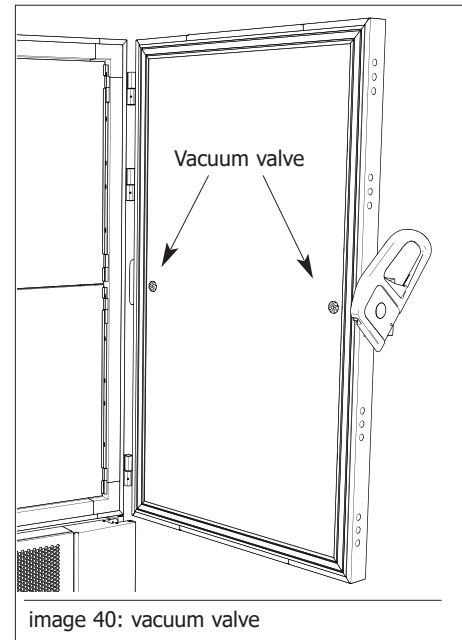

14.5 Replacement of the battery

- As on of messages "Low battery capacity", "Battery fault" or "Battery not connected" is displayed on the user interface, the connection of the battery must be controlled or the battery must be replaced.

Replacement of the battery:

- Remove the condenser cover.
- Remove the right bottom side cover of the unit (4 screws).
- Disconnect and remove old battery.
- Install new battery.
- Install the bottom side cover.
- Connect main plug.
- Turn on the device.
- Confirm "Battery replaced" on the user interface (image 39).

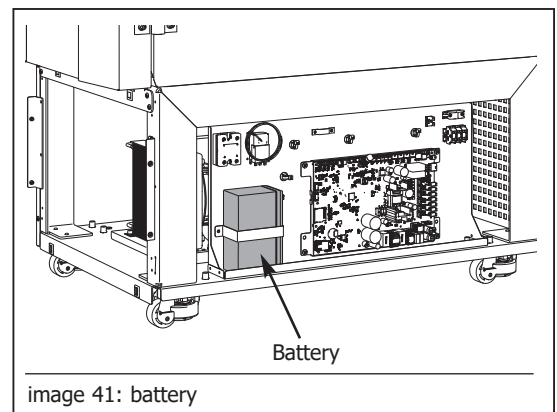

CAUTION

- After the battery is replace and the unit is first started, it may happen that the message „BATTERY FAULT“ appears. The message will disappear as soon as the battery is charged.

14.6 Repair



WARNING

- Before cleaning or carrying out maintenance work, switch the device off completely and pull out the mains plug.
- Only genuine spare parts must be used. Use of any other parts may affect the performance of the unit or cause physical injury or damage to the equipment.

- The battery should be replaced every 2 years as a preventive measure.
- A defective connection cable may not be repaired. It must be replaced by customer service or by a qualified electrical technician.

15 Disposal



WARNING

- Before scrapping an old unit, remove the door so that children cannot lock themselves inside while playing.
- Before scrapping the unit, remove the lead accumulator and the refrigerant. Dispose separately.
- When disposing of the unit, make sure that it does not get too hot, as combustible gas would cause the insulating foam to froth up.
- Follow the local prescriptions on disposal of hazardous equipment.

16 Troubleshooting

Problem	Cause	Possible solutions
Unit does not operate or Power Fail Alarm is on.	Power supply	<ol style="list-style-type: none"> 1. Check that the cord is securely plugged in. 2. Plug another appliance into the outlet to see if it is live. 3. Test the voltage and verify that it is correct for your unit. 4. If the outlet is dead, check the circuit breaker or fuses.
Temperature fluctuates.	Electronic	Make sure that the settings are correct.
	Condenser	Make sure the condenser is clean.
	Bad load	Check load condition and make sure load is evenly distributed and not blocking air circulation
	Other causes	If the electronic is setting is correct, the condenser is clean, but temperature continues to fluctuate, call an authorized service representative.
Unit warms up.	Door is open	Make sure the door is completely closed.
	Door seal	Check the door seal.
	Warm product recently loaded in unit	Allow ample time to recover from loading warm product.
	Power supply	Check for proper voltage to the unit. If there is no voltage to the unit, call an electrician.
	Compressor	<ol style="list-style-type: none"> 1. If the compressor is not running and the power failure alarm light is on, have an electrician check for proper voltage to the unit. 2. If the compressor is not running and the power failure alarm light is off, call the technical support hot line. 3. If the compressor is running, open the door and look through the slotted air intake in the bottom of the evaporator cover to see if icing is present on the evaporator. If icing is present and there is no air flow behind evaporator, call technical service for assistance. The evaporator fans may be inoperative. 4. If the compressor is running and there is airflow behind the evaporator, contact an authorized service provider or call the technical support hot line for assistance.

17 Technical Data

17.1 Blood bank refrigerators

Model	B401	B501	B701	B901
Gross volume [L]	478	634	792	949
Net volume [L]	390	517	645	773
Storage capacity [450mL bags]	270	360	450	540
Storage capacity [350mL bags]	375	500	625	750
External dimensions (HxWxD) [mm]	1988x699x1039	1988x845x1039	1988x992x1039	1988x1139x1039
Supply voltage (Frequency) [V (Hz)]	220 - 240V (50/60) 115 - 127 (60)			
Fuse	2x8A 5x20mm slow blow			
Set point [°C]	+4			
adjustable from ... to ...[°C]	NA			
Preset cold alarm [°C]	2.5			
(cold alarm adjustable from [°C])	(set point -1.5 to set point - 2)			
Preset warm alarm [°C]	5.5			
(warm alarm adjustable from [°C])	(set point +1.5 to set point + 2)			
Light power [W]	6.3			
Climate class	SN/T			
Ambient temperature range [°C]	10 ... 43			
Max Humidity [%]	75			
Power Rate @230V 50Hz[W]	300	300	300	300
Max Current consumption @230V 50Hz [A]	1.2	1.2	1.2	1.2
Power Rate @115V 60Hz [W]	300	300	300	300
Max Current consumption @115V 60Hz [A]	2.4	2.4	2.4	2.4

17.2 Plasma storage freezers

Model	F401(W)	F501(W)	F701(W)	F901(W)
Gross volume [L]	478	634	791	949
Net volume [L]	384	514	641	768
Storage capacity [350mL bags]	345	460	575	690
External dimensions (HxWxD) [mm]	1988x699x1039	1988x845x1039	1988x992x1039	1988x1139x1039
Supply voltage (Frequency) [V (Hz)]	230 (50) 220 (60) 115 - 127 (60)			
Set point [°C]	- 41			
adjustable from ... to ...[°C]	- 32 to - 41			
adjustable from to (at 43°C ambient) [°C]	-32			
Preset cold alarm [°C]	- 46			
(cold alarm adjustable from [°C])	(Set point - 5 to set point - 10)			
Preset warm alarm [°C]	-32			
(warm alarm adjustable from [°C])	(Set point + 5 to set point + 10)			
Climate class	SN/T			
Ambient temperature range [°C]	10 ... 43			
Max Humidity [%]	75			
Power Rate @230V 50Hz[W]	1300	1300	1300	1300
Max Current consumption @230V 50Hz [A]	8	8	8	8
Power Rate @220V 60Hz [W]	1300	1300	1300	1300
Max Current consumption @220V 60Hz [A]	8	8	8	8
Power Rate @115V 60Hz [W]	1300	1300	1300	1300
Max Current consumption @115V 60Hz [A]	16	16	16	16

17.3 Laboratory and pharmacy refrigerators

Model	L400/P400	L500/P500	L700/P700	L900/P900
Gross volume [L]	478	634	792	949
Net volume [L]	390	517	645	773
External dimensions (HxWxD) [mm]	1988x699x1039	1988x845x1039	1988x992x1039	1988x1139x1039
Supply voltage (Frequency) [V (Hz)]	220 - 240 (50/60) 115 - 127 (60)			
Fuse	2x8A 5x20mm slow blow			
Set point [°C]	+5			
adjustable from ... to ... [°C]	+4 to +15			
Preset cold alarm [°C]	+ 3			
(cold alarm adjustable from [°C])	(set point - 2 to set point - 20)			
Preset warm alarm [°C]	+ 7			
(warm alarm adjustable from [°C])	(set point + 2 to set point + 20)			
Light power [W]	6.3			
Climate class	SN/T			
Ambient temperature range [°C]	10 ... 43			
Max Humidity [%]	75			
Power Rate @230V 50Hz[W]	300	300	300	300
Max Current consumption @230V 50Hz [A]	1.2	1.2	1.2	1.2
Power Rate @115V 60Hz [W]	300	300	300	300
Max Current consumption @115V 60Hz [A]	2.4	2.4	2.4	2.4

17.4 Laboratory freezers

Model	F400(W)	F500(W)	F700(W)	F900(W)
Gross volume [L]	478	634	791	949
Net volume [L]	384	514	641	768
External dimensions (HxWxD) [mm]	1988x699x1039	1988x845x1039	1988x992x1039	1988x1139x1039
Supply voltage (Frequency) [V (Hz)]	230 (50) 220 (60) 115 - 127 (60)			
Set point [°C]	- 41			
adjustable from ... to ... [°C]	- 20 to - 41			
adjustable from to (at 43°C ambient) [°C]	- 20 to -32			
Preset cold alarm [°C]	- 46			
(cold alarm adjustable from [°C])	(set point - 5 to set point - 10)			
Preset warm alarm [°C]	-32			
(warm alarm adjustable from [°C])	(set point + 5 to set point + 10)			
Climate class	SN/T			
Ambient temperature range [°C]	10 ... 43			
Max Humidity [%]	75			
Power Rate @230V 50Hz[W]	1300	1300	1300	1300
Max Current consumption @230V 50Hz [A]	8	8	8	8
Power Rate @220V 60Hz [W]	1300	1300	1300	1300
Max Current consumption @220V 60Hz [A]	8	8	8	8
Power Rate @115V 60Hz [W]	1300	1300	1300	1300
Max Current consumption @115V 60Hz [A]	16	16	16	16

17.5 Ultra low freezers

Model	U201(W)	U401(W)	U501(W)	U701(W)	U901(W)
Gross volume [L]	232	478	634	791	949
Net volume [L]	217	454	602	751	900
Storage capacity [cryobox H50]	150	300	400	500	600
External dimensions (HxWxD) [mm]	1293x699x1039	1988x699x1039	1988x845x1039	1988x992x1039	1988x1139x1039
Supply voltage (Frequency) [V(Hz)]	230 (50) 220 (60)				
Set point [°C]	- 82				
adjustable from ... to ... [°C]	- 20 to - 86				
adjustable from ... to ... (at 43°C ambient) [°C]	- 20 to - 80				
Preset cold alarm [°C] (cold alarm adjustable from [°C])	- 87 (set point - 5 to set point - 50)				
Preset warm alarm [°C] (warm alarm adjustable from [°C])	- 77 (set point + 5 to set point + 50)				
Climate class	SN/T				
Ambient temperature range [°C]	10 ... 43				
Max Humidity [%]	75				
Power Rate @230V 50Hz[W]	2000	2000	2000	2000	2000
Max Current consumption @230V 50Hz [A]	10	10	10	10	10
Power Rate @220V 60Hz [W]	2000	2000	2000	2000	2000
Max Current consumption @220V 60Hz [A]	10	10	10	10	10

18 Track change

ed0520 Updates:

- Page 2: Updated reference to MDR
- Page 8: Caution on interior fittings
- Page 21: RAR = Remote Alarm Reset
- Page 32: Further explanation on confirmation of Remote alarm
- Page 33: Caution on interior fittings
- Page 44: Addition of 14.3 Removing ice and frost
- Page 47 - 49: Additional information

ed1020 Updates:

- General addition of U201
- Page 13: over-current fuses for all F
- Page 29: 10 second delay for a powerfail
- Page 41: Warning for calibration in °C
- Page 9-10: Update of the intended use
- Page 11: Change of minimum distance between units
- Page 49: Setpoint change to -20°C to -86°C for the Ultralow freezers
- Page 44: Removal of Vacuum release valves for F models

ed1120 Updates:

- Page 10: Addition of 2.6 Operating conditions and warning
- Page 47-49: Updated information
- Page 29: Chapter 8.3 clarification on high condensing temperature

ed0321 Updates:

- Page 25: User access rights update.

ed0322 Updates:

- Page 9: Inclusion of packaging label
- Page 10: Update of intended use.
- Page 16: Addition of caution related to the positive assessment of the temperature display by a user
- Page 28: Addition of caution related to the use of remote monitoring when user is not physically present.
- Page 38: Addition of BConnected and RTMD
- Page 48-50: Update of technical data

ed0522 Updates:

- Page 17: Addition of warning for manual override of door opening
- Page 44: Addition of preventive maintenance

ed0223 Updates:

- Page 10: Update of intended use: Laboratory and pharmacy refrigerators



B Medical Systems S.à r.l.
op der Hei 17
L - 9809 Hosingen, Luxembourg