

Instructions for use

Cell Washer Centrifuge Hettich Rotolavit II and Rotolavit II-S

manufactured by

Hettich AG
Seestrasse 204a
CH-8806 Baech / Switzerland

phone +41 (0)44 786 80 20
info@hettich.ch
www.hettich.ch

© 2022 by Hettich AG

All rights reserved. No part of this publication may be reproduced without the prior written permission of the copyright owner.

Modifications reserved!

Contents

1	Used terms and signs	6
1.1	Explanation of the terms	6
1.2	Explanation of signs	6
2	Use according to the specifications	7
2.1	Versions	7
2.2	Storage and forwarding the operator-manual	7
2.3	Responsibility of the owner	8
2.4	Requirements of the operating personnel	8
2.5	Changes and alterations	8
2.6	Warranty	9
3	Notes on safety	9
4	Behaviour in case of malfunctions and irregularities	11
4.1	Remaining risks	11
4.2	Switching off the device in an emergency	11
4.3	Emergency release	11
5	Technical specifications	13
6	Unpacking the centrifuge	14
6.1	Storage after delivery	14
6.2	Installation after storage	14
6.3	Delivery checklist	15
6.4	Disposing of packaging material	15
6.5	Transportation	15
6.6	Labelling (Nameplate)	15
7	Installing the wash centrifuge	16
7.1	Connections	16
7.2	Accessory	17
7.3	First steps	18
7.4	Starting the wash centrifuge	20
7.5	Install and remove the rotor	20
8	Operation settings	21
8.1	Overview	21
8.1.1	Password protection	22
8.2	Start screen	22
8.3	Select program	23
8.4	Add a new program	23
8.5	System settings	23

8.5.1	History	24
8.5.2	Language, date and time settings	24
8.5.3	Edit password	24
8.6	Service menu	25
8.6.1	Calibration	25
8.6.2	User settings	26
8.6.3	Device settings	26
8.6.4	Network settings	27
9	Programs	27
9.1	Validation	27
9.2	Starting the program	28
9.3	Stop a running program	29
9.4	Pre-installed programs	30
9.4.1	flush	30
9.4.2	refill pump	30
9.4.3	wash redcells 3 5ml 3x (wash erythrocytes, 3.5 ml, 3 x)	31
9.4.4	agit and spin	31
9.4.5	decant	31
9.4.6	spin 20sec 3500rpm	31
9.4.7	susp 3 5ml spin 20sec (centrifuge 3.5ml suspension for 20sec)	31
9.4.8	wash 3 5ml 3x and anti (wash 3.5 ml, 3 x, plus antihuman globulin test)	32
9.4.9	wash white cells Tspot (wash leukocytes, Tspot)	32
9.4.10	cell recovery (only device type 1008-00S)	32
9.4.11	immunophenotyping (only device type 1008-00S)	32
9.5	Process descriptions	33
9.5.1	Principle	33
9.5.2	FILL 1 process	33
9.5.3	FILL 2 process	33
9.5.4	DOWN process	34
9.5.5	SPIN process	34
9.5.6	DECANT process	35
9.5.7	AGIT process	35
9.5.8	LOOP process	36
9.5.9	CHECK process	36
9.6	Add a new program	37
10	Adjusting	39
10.1	Entering the rotor type	39

10.2	Calibrating the filling volume	39
10.3	Audible signal	40
10.4	Relative centrifugal force (RCF)	40
10.5	Querying operating hours	40
11	Maintenance and servicing	41
11.1	Centrifuge	41
11.2	Rotor	42
11.3	Autoclaving	43
11.4	Removal of the splash guard receiver and cap	43
11.5	Flushing the system with deionized or distilled water	43
11.6	Cleaning the system with cleaning solution	43
11.7	Glas breakage	44
11.8	Repairs	44
11.9	Rotor crash	44
11.10	Maintenance schedule	45
12	Faults and errors	46
12.1	Operator faults	46
12.2	Software error codes	47
12.3	Changing the fuse	49
13	Returning the device / parts of it	49
14	Storage	49
14.1	Disposal	50
15	Appendix	51
15.1	Rotors and accessories	51
15.2	Spare parts	53
15.3	Document history	54

1 Used terms and signs

In this manual and on the device, certain common terms and signs are used to warn you of possible dangers or to give you hints that are important in avoiding injury or damage. Observe and follow these hints and regulations to avoid accidents and damage. These terms and signs are explained below.

1.1 Explanation of the terms

Warning is used whenever you or somebody else could be injured if you do not observe the accompanying safety regulation.

Caution is used for information that is important for avoiding damage.

1.2 Explanation of signs

Caution is used for information that is important for avoiding damage.



Symbol on the device:

Attention, general hazard area.

Before using the device, make sure you read the operating instructions and observe the safety information!



Symbol in this document:

Attention, general hazard area.

This symbol refers to safety relevant warnings and indicates possibly dangerous situations.

The non-adherence to these warnings can lead to material damage and injury to personnel.



Symbol in this document:

This symbol refers to important circumstances.



Symbol on the device and in this document:

Beware of biohazard.



Symbol on the device and in this document:

Symbol for the separate collection of electric and electronic devices according to the guideline WEEE. The device belongs to Group 8 (medical devices).

Applies in the countries of the European Union, as well as in Norway and Switzerland.



Symbol in this document:

Disconnect the mains plug



Symbol in this document:

Wear protective gloves



Symbol in this document:

Important or useful additional information

2 Use according to the specifications

The present device is a wash centrifuge intended for in-vitro diagnostic applications, in accordance with "Directive 98/79 EC". The sample processing with the use of the device and the corresponding inserts is realised by the filling with a washing liquid and subsequent shaking, centrifuging and decanting. The device itself is used for sample processing and not for sample analysis.

The following device types are available for this device:

Rotolavit II, Type 1008-00

These device types are used to wash erythrocytes for carrying out quick anti-human globulin tests (direct and indirect Coombs tests) in crossmatch, antibody screening and differentiation.

Leukocytes can be washed in the same way to prepare samples for tuberculosis testing. The device is intended exclusively for the applications mentioned and is only allowed to be used in closed clinical laboratories by medically trained specialists.

Rotolavit II-S, Type 1008-00S

This device type is used to wash blood or other cell-containing samples to prepare the flow cytometric analysis on a sample preparation system and flow cytometer. The process steps can be individually configured by the user and stored in the device. The configured process steps are processed automatically by the device. A wash-cycle may consist of several processes in which the samples are centrifuged, the supernatant decanted, and then each sample tube is filled with a physiological saline solution and mixed.

The device should only be used by trained medical personnel in clinical laboratories and used only for the stated purpose.

The life cycle of the device specified by the manufacturer is seven years. The lifetime of some parts of the accessories is divergent and is specified in chapter 12.10 of this manual.

Any other use beyond this purpose, as well as non-observance of the intended use (see instructions in the operating instructions regarding transport, storage and execution of cleaning, inspection and maintenance work) is considered to be improper use. The company Hettich AG accepts no liability for any damage arising from this.

2.1 Versions

The device is available in different configurations. If specific equipment features or functions are available only for certain configurations, this is indicated at the relevant points in this manual. The functions described in this manual refer to the latest software version. This manual was written in accordance with the software-version 1.01.424.

2.2 Storage and forwarding the operator-manual

This instruction manual belongs with the device and should always be stored where persons working on the device have access to it. It is the responsibility of the owner to ensure that persons who are working or will work on the device are informed as to the whereabouts of this operator manual. We recommend that it is always stored in a protected location close to the device. Make sure that the instruction manual is not damaged by fluid or humidity. If the device is sold on or transported and then set up again at a different location, the operator manual must go with it.

2.3 Responsibility of the owner

The owner of the device:

- is responsible for the flawless condition of the device and for its proper operation in accordance with the specifications.
- is responsible for ensuring that persons who are to operate or service the device are qualified to do this, have been instructed accordingly and are familiar with the operating manual at hand.
- must know about the applicable guidelines, requirements and operational safety regulations, and train staff accordingly.
- is responsible for ensuring that unauthorized persons have no access to the device.
- is responsible for ensuring that the maintenance plan is adhered to and that maintenance work is carried out properly (see chapter 12).
- must ensure that the device and its surroundings are kept clean and tidy, for example through corresponding instructions and inspections.
- is responsible for ensuring that personal protective clothing is worn by operating personnel, e.g. work-clothes, protective gloves.
- is responsible for ensuring that before starting work with this device all qualifications are released, the IQ (Installation-Qualification), the OQ (Operational-Qualification) and PQ (Process-Qualification).
- is responsible for periodic routine to flush, clean and disinfect the device as well, described in chapter 12, and take care of controlling the used fluid for the needed quality.
- is responsible for the use of the password-protection, user-settings (cha.8.6.2).

2.4 Requirements of the operating personnel

The device may only be operated and maintained by persons who are of legal age and have been instructed accordingly. Personnel who are to be trained, instructed or who are undergoing general training may only work with the appliance under the continuous supervision of an experienced person.

Repairs may only be performed by qualified electricians who are authorised to do so by the manufacturer. The regulations in the separate service manual must be observed.

2.5 Changes and alterations

No unauthorized changes or alterations may be made to the device. No parts may be added or inserted which have not been approved by the manufacturer.

Unauthorized modifications or changes result in the CE declaration of conformity losing its validity and the device should no longer be operated.

The manufacturer is not liable for any damage, danger or injuries that result from unauthorized changes or alterations, or from non-observance of the regulations in this manual.

2.6 Warranty

No claim of warranty will be considered by the manufacturer unless **ALL** instructions in this manual have been followed. Especially the flow-sensor and the magnetic-valve are excluded from a warranty exchange if they are enriched with salt-crystals and this happens if the information in chapter 12 are not followed.

No claim of warranty will be considered by the manufacturer when an unauthorized modification is implemented or non-authorized parts are installed.

3 Notes on safety



No claim of warranty will be considered by the manufacturer unless ALL instructions in this manual have been followed.



The centrifuge should be installed on a good, stable base. We suggest that no other critical device, like a balance, microscope or HPLC, is placed onto the same base.



The centrifuge should be set up so that no containers with e. g. liquids can fall down onto the centrifuge



When the centrifuge is running, according to EN / IEC 61010-2-020, no persons, dangerous substances or objects may be within the safety margin of 300 mm around the centrifuge.



Rotors, suspensions and accessories that possess traces of corrosion or mechanical damage or if their term of use has expired may not be used any longer.



The centrifuge may no longer be put into operation when the centrifuging chamber has safety-related damage.

For centrifuges without temperature control, when the room temperature is increased and/or if the device is frequently used, the centrifuging chamber could be heated up. Therefore, it can't be ruled out that the sample material might be changed due to the temperature.

Before the initial operation of your centrifuge you should read and pay attention to the operating instructions. Only personnel that has read and understood the operating instructions are allowed to operate the device.

The centrifuge may not be operated in explosion-endangered areas.

The centrifuge should not be used with:

- inflammable or explosive materials
- materials that react with one another producing a lot of energy

Along with the operating instructions and the legal regulations on accident prevention, you should also follow the recognised professional regulations for working in a safe and professional manner. These operating instructions should be read in conjunction with any other instructions concerning accident prevention and environmental protection based on the national regulations of the country where the device is to be used.

This centrifuge is a state-of-the-art piece of equipment which is extremely safe to operate. However, it may pose a risk to the user or third parties if it is not used by trained personnel, improperly or in accordance with its intended purpose.

The centrifuge should not be moved or knocked during operation.

In case of fault or emergency release, never touch the rotor before it has stopped turning.

To avoid damage due to condensate, when changing from a cold to a warm room the centrifuge must either heat up for at least 24 hours in the warm room before being connected to the mains.

Only the rotors and accessories approved by the manufacturer for this device may be used, see chapter "rotor and accessories". Before centrifuge tube-holders, reducers, which are not listed in the chapter "rotors and accessories", the user should make sure they can be used by asking the manufacturer of the device.

When centrifuging with maxim revolutions per minute the density of the materials or the material mixtures may not exceed 1.2 kg/dm^3 .

The centrifuge may only be operated when the balance is within the bounds of acceptability
 $\leq 5g = \text{pass}$ and $\geq 10g = \text{stop}$

If users centrifuge hazardous materials or compounds contaminated with toxic, radioactive or pathogenic micro-organisms, they must take appropriate work-instruction measures.

Repairs must only be carried out by personnel authorised to do so by the manufacturer.

Only original spare parts and original accessories licensed by the manufacturer can be utilised.

Components contaminated with blood (e.g. rotor, centrifugation area, waste-tube and connectors) must, following replacement, be disposed of in the special waste for materials contaminated with blood.

The following safety regulations apply:

EN / IEC 61010-1 and EN / IEC 61010-2-020 as well as their national deviations.

The safe operation and reliability of the centrifuge can only be guaranteed if:

- the centrifuge is operated in accordance with the operating instructions
- the electrical installation on the site where the centrifuge is installed conforms to the demands of EN / IEC stipulations
- the tests for device safety required in the respective countries, e.g. in Germany in accordance with "DGUV Vorschrift 3", are carried out by an expert.

4 Behaviour in case of malfunctions and irregularities

The device may only be used in a flawless condition. If you as the operator notice irregularities, malfunctions or damage, immediately take the device out of work and inform your superior.



You can find on correcting malfunctions in chapter 13.

4.1 Remaining risks

The device is built according to the state-of-the-art and the recognized safety regulations. If used and handled improperly, there could be life-threatening danger to the user or third parties, the device could be impaired or there could be other property damage. The device is only to be used for its intended purpose and only when it is in safe working condition. Malfunctions which could affect safety must be corrected immediately and until then the device must be taken out of service.



In the event of serious incidents with the device, report them to the manufacturer or, if necessary, to the competent authority.

4.2 Switching off the device in an emergency

Push the on / off switch on the rear-panel to its off-position and disconnect the power plug. This disconnects the device from the power supply at all poles.

4.3 Emergency release



The lid cannot be opened during power failure. An emergency release has to be executed by hand.



For emergency release disconnect the centrifuge from the mains.

Open the lid only during rotor standstill.

Only the plastic release pin provided may be used for emergency release.

- Switch off the mains switch (switch position "0").
- Look through the window in the lid to be sure that the rotor has come to a standstill.
- Insert the release pin horizontally into the hole. Push the unlocking pin in until the handle can be lifted when the pin is pressed in.
- Open the lid.
- An error appears on the display after switching on the centrifuge.

5 Technical specifications

Modell	Rotolavit II	Rotolavit II-S
Part-Nr.	1008-00	1008-00S
Base UDI-DI	07640173551003	07640173554004
Class conform 2017/746 (EN)	class A, conform appendix VIII, rule 5	
External power supply	100–240 V~ (single phase)	
Mains frequency	50-60 Hz	
Protection class	class I	
Connected load	144 VA	
Current consumption	0,7 A (230 V~) bzw. 6 A (24 V=)	
Power	150 W	
Fuse	10 A / 250 V F	
Width	330 mm	
Depth	480 mm	
Height, closed lid	280 mm	
Height, open lid	580 mm	
Weight	24,4 kg	
Capacity, standard	12 x 5 ml	
Capacity, optional	24 x 5 ml	
Speed / radius	3500 RPM / 105 mm	
Force	1438 RZB	
Kinetic energy, max.	250 Nm	
Max. allowed density	1,2 kg / dm ³	
Max. Fülltoleranz	± 0.3ml @ 24- places rotor / 3.5ml filling quantity	
Obligatory inspection (BGR 500)	no	
EMC	IEC61326-3-2 / FCC CFR47, part 15, ed 2015, class B	
Noise level	62dB	
Ambient conditions nach EN / IEC61010-1	Not suitable for use in explosion endangered areas indoors only	
Ambient altitude	up to 2000m above sea level	
Ambient temperature	18 °C to 30 °C	
Humidity	20 %rH to 80 %rH / non-condensing	
Storage temperature	5 °C to 50 °C / max. 60%rH	
Buffer battery	CR 2032	

tab. 1.0

6 Unpacking the centrifuge



If packaging arrives damaged, it must be confirmed by the carrier and the centrifuge must be specially inspected.



To avoid damage, do not unpack the appliance until you reach the installation site. Check the delivery note to ensure that the delivery is complete. Check the appliance for damage.



Take care, you could injure your skin on the edge of the cardboard packaging carton.



Lift the centrifuge on both sides and not on the frontpanel. Take it out of the box with an adequate amount of people to help you.



According to the laboratory instrument standards EN / IEC 61010-2-020 an emergency switch to disconnect the power supply in the event of a failure must be installed in the building electrical system. This switch has to be placed remote from the centrifuge, preferably outside of the room in which the centrifuge is installed or near by the exit of this room.



Before the centrifuge is connected to the power or the lid is opened using the emergency opening, place the centrifuge carefully on one side so that the three transport locking screws on the underside of the centrifuge can be removed with the help of the enclosed hexagon L-key wrench. Carefully place the centrifuge back on its feet, connect the power correctly, and operate the centrifuge and open the lid, so that the transport foam of the supplied rotor, or the additional transport lock on delivery without rotor, can be removed.



Position the centrifuge in a stable and level manner in a suitable place. During set-up, the required safety margin of 300 mm around the centrifuge is to be kept according to EN / IEC 61010-2-020.1 When the centrifuge is running, according to EN / IEC 61010-2-020, no persons, dangerous substances or objects may be within the safety margin of 300 mm around the centrifuge.



The centrifuge was packed under non-sterile conditions.

If you notice deviations from the delivery note, damage or irregularities, do not put the appliance into operation, but inform the haulage company and your supplier.

If possible, keep the transportation material and the transportation safety device in a safe and dry place.

6.1 Storage after delivery

If the device must first be stored after delivery, then check the box from outside for damage and if it is so, inform the haulage company and your supplier immediately. For the storage conditions, refer to tab. 1.0 technical specifications.

6.2 Installation after storage

If the storage environment was outside the working environment, then you must allow the device to acclimatise to the new environment for 24 hours without connecting to the power.

6.3 Delivery checklist

- 1 power-supply, fig. 7.2.4
- 1 drainage hose (Ø 14,3 mm) with connector, E4374, fig. 7.2.3
- 1 fill hose (Ø 7,1 mm) with connector, E4373, Inlet 1, with intake pipe; for the physiological saline solution, E4373
- 1 fill hose (Ø 7,1 mm) with connector, Inlet 2 (Fluid 2), with intake pipe for a secondary solution ^{*1}
- 1 angle piece (plastic), for the drainage hose (for free-running drain), E4394, fig. 7.2.1
- 1 power-cord
- 1 battery-cord (with open wires) ^{*2}
- 1 release-pin, E2287, fig. 7.2.1
- 1 hex L-key, fig. 7.2.1

The rotor(s) and associated accessories are included in the delivery in the quantity ordered.

^{*1} would be delivered only for devices with the optional secondary pump (p/n 1008-02 and 1008-04)

6.4 Disposing of packaging material

Dispose of the packaging material (cardboard, polyurethane foam, tie and plastic bag) in accordance with the applicable disposal regulations for the respective material in your country. If you have any questions, please contact your local supplier. We recommend to keep at least one set of the original packaging for transporting (Chap. 6.5).

6.5 Transportation

Please store the original packaging and use it for transportation. If you have to transport the device and you do not have the original packaging material anymore, please contact your local supplier. The device and its motor and rotor must be protected during transportation.

6.6 Labelling (Nameplate)



Abb. 6.6

Legend:

- | | | | |
|---|------------------------|---|----------------------------------|
| 1 | Type designation | 5 | Manufacturer's address |
| 2 | Part number | 6 | Disposal note |
| 3 | Serial number | 7 | QPS certification, CE-conformity |
| 4 | Main connection values | 8 | Date of manufacture |

7 Installing the wash centrifuge

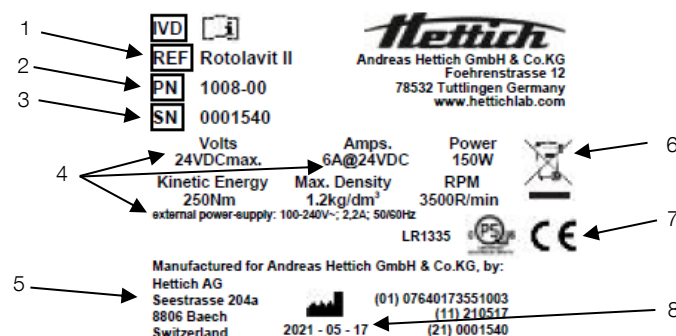
7.1 Connections

- 1 solution tube to the lid
- 2 mounting bracket for the power-supply
- 3 ON / OFF main switch
- 4 Ethernet interface
- 5 DC power input *
- 6 fuse, fuse holder
- 7 inlet 1, saline
- 8 inlet 2, solution 2*
- 9 outlet, drain

* Refer to the technical specifications comparing to The part number from your device, tab 1.0

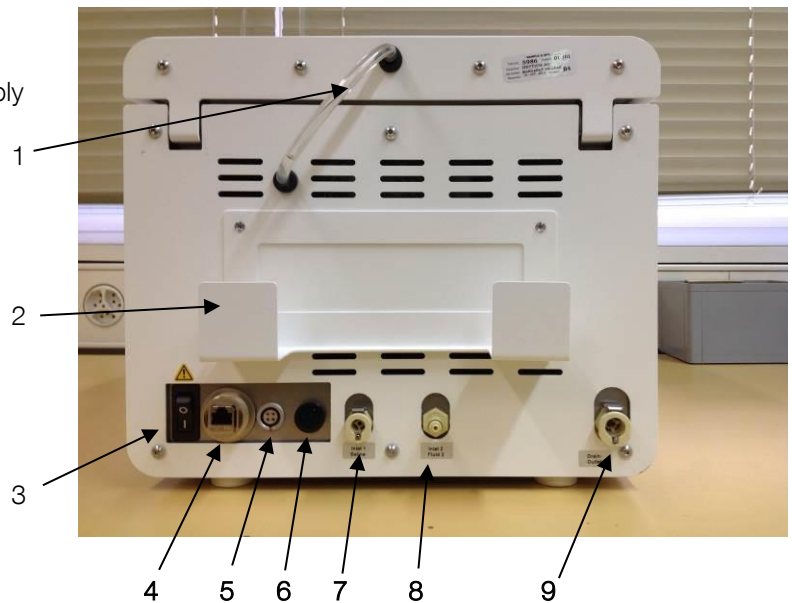

fig. 7.1



- 9 Emergency release hole
(Refer to chapter 4.3)

Fig. 7.2



Refer to the technical specifications comparing to the part number from your device, tab 1.0
Allow the option to be installed only from an authorised distributor.

7.2 Accessory

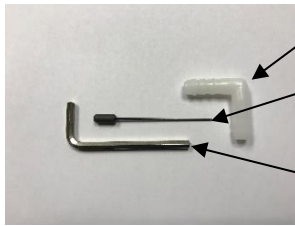

Fig. 7.2.1

E4394, angle piece
E2287, emergency-release pin
hex L-Key

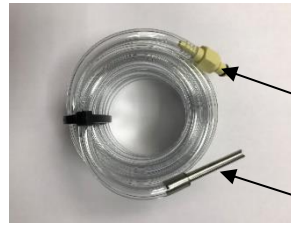

Fig. 7.2.2

E4373, fill-hose, Inlet 1, complete
E4261, plug, input 1
E4258, weight for suction tube



Fig. 7.2.3

E4374, drain hose, complete
E4259, plug, for waste tube



Fig. 7.2.4

E4251 / E4502, power-supply



The Angle piece is for the drain hose. This ensures that the liquid runs off and no siphon is created. If liquid back into the device and fills the bowl, your device (motor) will be damaged.



Fig. 7.2.5



Fig. 7.2.6

7.3 First steps

Please check chapter 3 before starting the installation.

Install the power supply in its mounting bracket on the rear side (see Fig. 7.1, Pos. 2) and plug the connector to the DC input (Fig. 7.1, Pos. 5). Plug the provided main power cable into the power supply and the other side to the power source.



Check the country-specific regulations when making connections (e.g. in Germany with residual current circuit breaker). Observe the connection and power ratings, see on the label and the technical specification. Make sure to establish a safe PE conductor connection.



Lay the power cable so that

- it is always accessible and within reach, so it can be disconnected in the event of a failure
- no one can trip over it
- it does not have contact with a solution, e.g. water or saline, mechanical parts, e.g. shakers or mixers, or hot parts, e.g. ovens or torches



Plug the connector from the fill hose to the inlet 1 on the rear side (Fig. 7.1, Pos. 7) and dip the other side with the suction-tube into the container with the saline solution.

If the fill hose is too short for your installation and it is not possible to move the can with the solution closer and you need an oversized fill hose (from your local distributor), then you must validate the flush- and the refill pump programs for correct operation.

If your device has the optional inlet 2, plug the connector from the fill hose 2 to the inlet 2 on the rear side, see on fig. 7.1, Pos. 8 afterwards dip the other side with the suction tube into the container with the fluid 2 solution.



Ensure that it is not possible to interchange the ends from the tubes and the cans or containers, otherwise all probes will be disturbed!



Plug the connector from the drainage hose to the outlet on the rear side, see on fig. 7.1 pos. 9, and put the other side into the waste.



Ensure that the drainage hose lies flat onto the base, if not and it is like figure 7.2.6, the device will become damaged.



Clean and disinfect the device before first use.

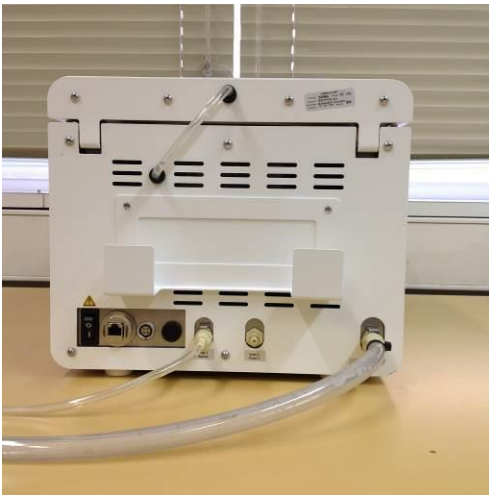

fig. 7.4



fig. 7.3

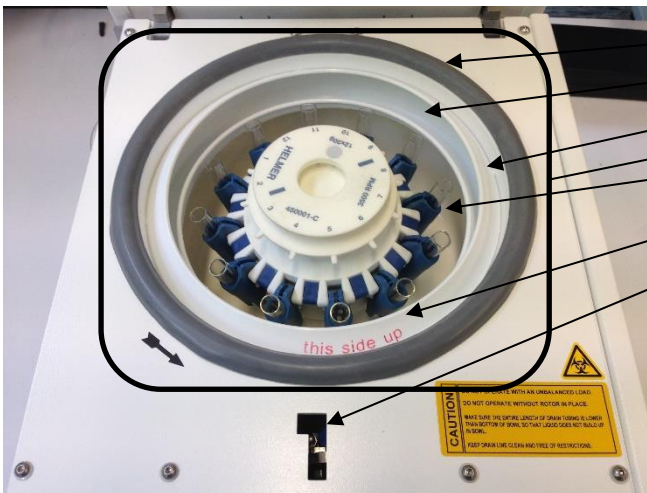

fig. 7.5

- seal
- splash guard receiver
- splash guard cap
- centrifugation area
- bowl
- inscription (just on fig. in red)
- lid lock access hole

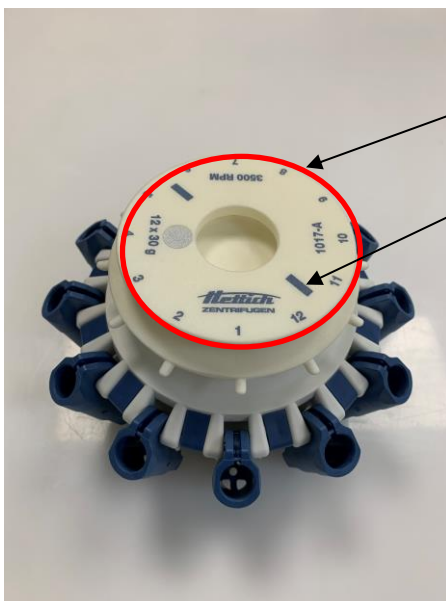

fig. 7.6

- handle to lift the rotor
- marking for positioning the rotor

7.4 Starting the wash centrifuge

Push the ON / OFF main switch (fig. 7.1, Pos. 3). The start initialization needs approx. one minute.

When the main screen appears push the lid-open button and open the lid, chapter 8.2 pos.7, remove the transportation safety device from the top of the rotor and keep it in a safe place.

7.5 Install and remove the rotor

Either a 12-place rotor or a 24-place rotor may be installed in the Rotolavit II and Rotolavit II-S. Both rotors can hold either 10 mm x 75 mm tubes or 12 mm x 75 mm tubes, glass- or plastic-types. A rotor must be installed and the setup must be correctly to operate, see cha. 8.5 systems settings and cha. 10.1 Entering the rotor-type.

Rotor installation procedure:

1. Grasp the rotor on the grip area (fig. 7.6, pos. 1) and place the rotor over the motor-axis.
2. Align the markings (fig. 7.6, pos. 2) on the top of the rotor with the slots on the motor-axis.
3. Lower the rotor onto the motor-axis.



If the rotor is placed incorrectly over the motor-axis, then it is not possible to close the lid.

Rotor removal procedure:

1. Open the lid.
2. Grasp the rotor on the grip area and lift the rotor straight up.

8 Operation settings

8.1 Overview

Operation settings for the Rotolavit II can be viewed and changed through the system settings menu.

Software version: 1.01.424

Legend:

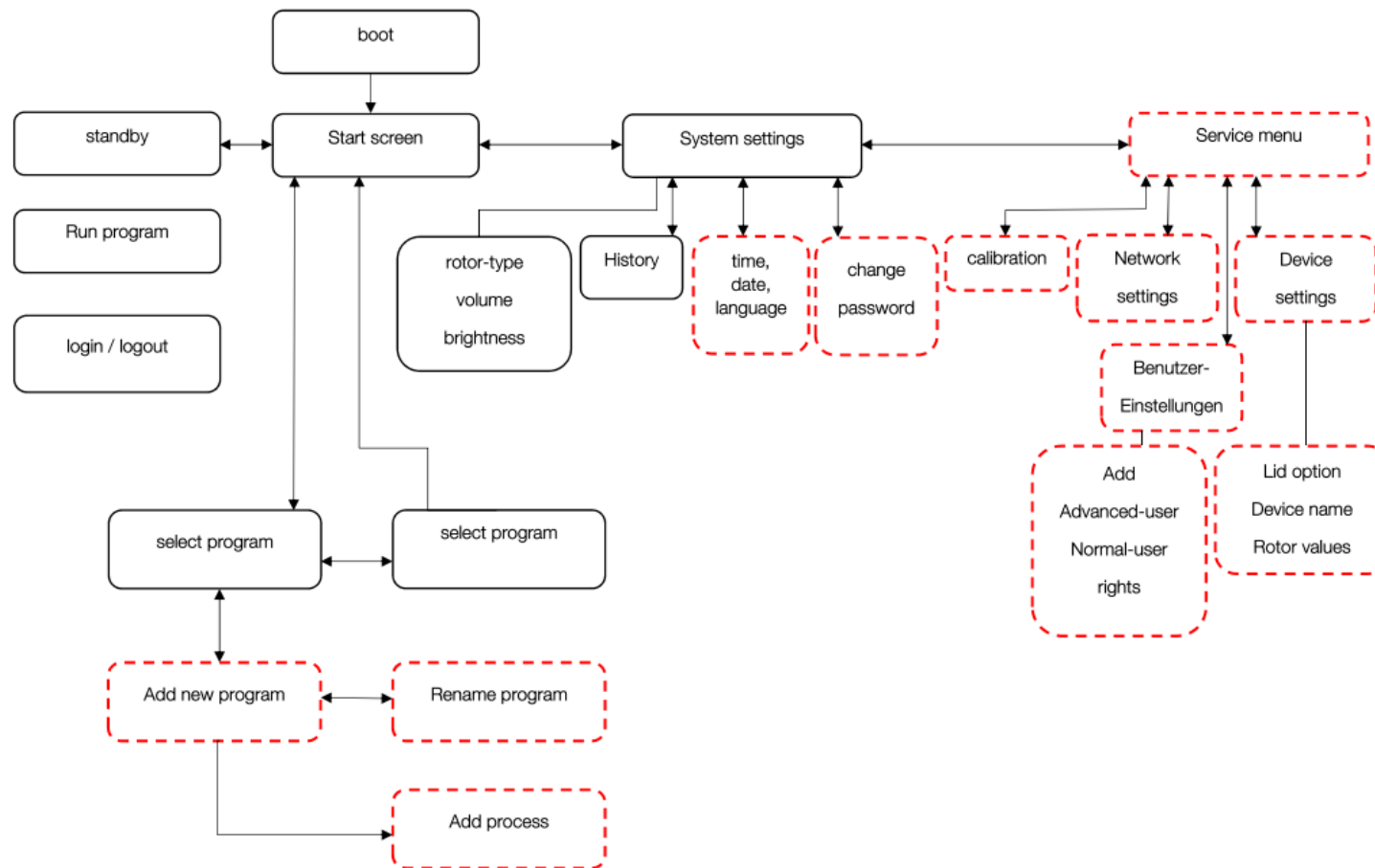
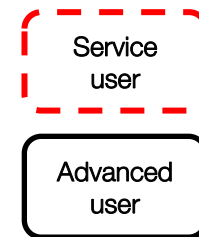

8.1.1 Password protection

Some operating functions are restricted for the "Normal User" level and some can be restricted (R) in the "User Settings" menu, see chapter 8.6.2. But to do this, the service user password is needed. On delivery the password for the Advanced User is "1008" (name can be changed), see also the following table:



If you have to be logged in for an action with a password, it is specified in this manual with [Login].

Function for software rev. 424	Normal user	Advanced user	Service user	Factory user
select program	√ (R)	√	√	√
start program	√ (R)	√	√	√
check function	√ (R)	√	√	√
abort program (stop)	√ (R)	√	√	√
add / edit program		√	√	√
select rotor type	√ (R)	√	√	√
view history	√	√	√	√
reset rotor operating time			√	√
change time / date settings		√	√	√
add / change / delete Adv. User Name			√	√
add / change / delete Adv. User Password			√	√
calibrate filling volume			√	√
change device settings				√
change password		√	√	

8.2 Start screen



1. name of the selected program
2. start program [Login]
3. standby, dark display, reduced power
4. system settings, device settings
5. login / logout
6. select a program
7. open lid



The service user can restrict for the normal user the possibility to start a program.

8.3 Select program

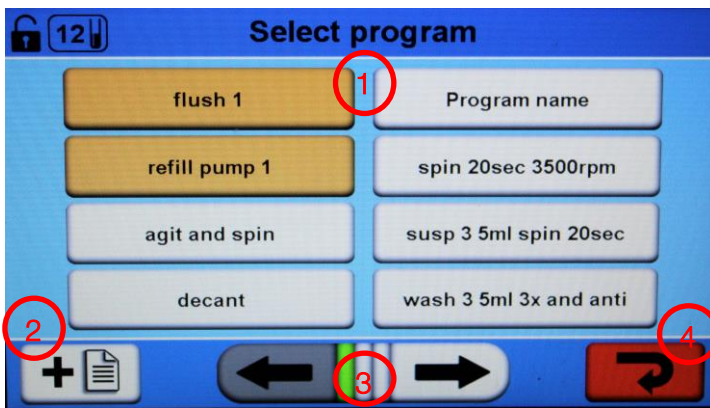

1. existing programs
2. add a new program [Login]
3. navigate through the existing program listing
4. back to start screen



The individual programs must be matched or validated by the operator to the **customer-specific tubes**. The Rotolavit II, II-S has a memory capacity for a total of 24 programmes including the two system programmes flush 1 and pump 1.

8.4 Add a new program

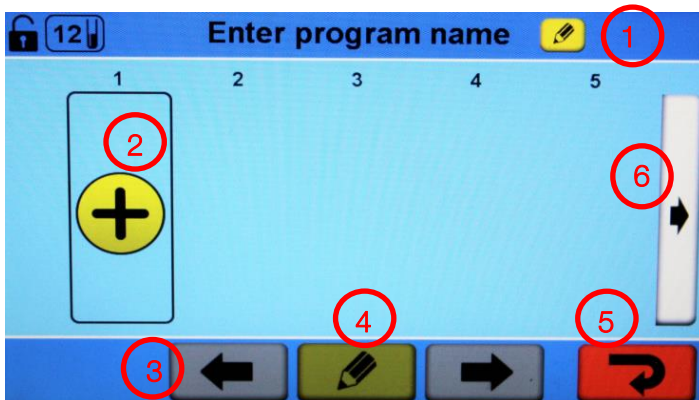

1. rename program [Login]
2. add process [Login]
3. select an existing process of the program [Login]
4. edit process [Login]
5. back without saving [Login]
6. navigate through existing processes [Login]

8.5 System settings



It is necessary to enter the rotor type used (12-place or 24-place) in order to calculate the filling volume and it is only possible to enter the rotor type when the rotor has stopped.

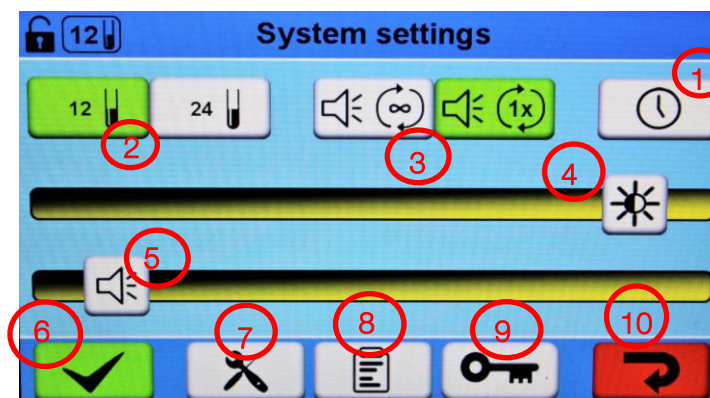

1. time-, date- and language settings [Login]
2. change rotor type [Login]
3. beep at the end of a program
4. brightness control
5. beep volume control
6. save changes
7. service menu [Login]
8. History
9. edit password [Login]
10. back without saving

8.5.1 History

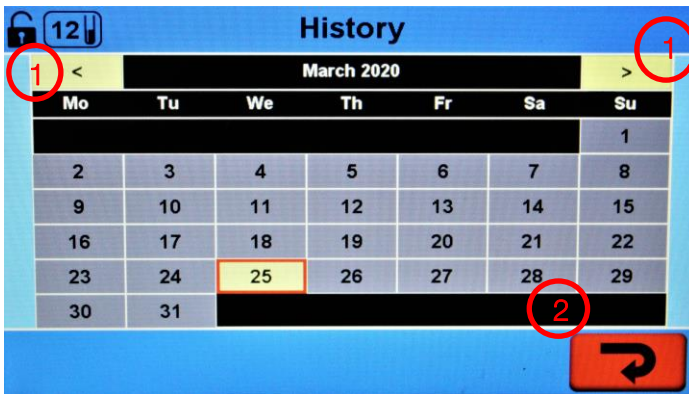

1. last or next month
2. return to system settings



The days with a highlighted background have some saved data / runs.



Is the history date far from the current date, switch off the device (from that screen) with the main switch, wait 10 seconds and switch on again, the next time the history is selected, the current date will appear.

8.5.2 Language, date and time settings

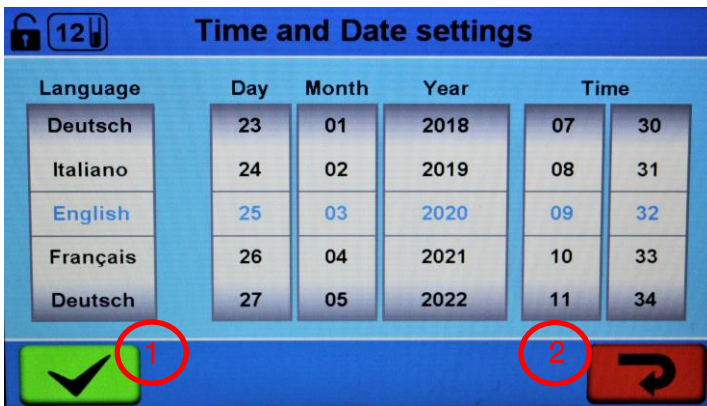

Wheel adjuster for language, date and time preferences [Login]

1. accept changes
2. discard changes and return to system settings



After changing the language, a restart must be performed.

8.5.3 Edit password

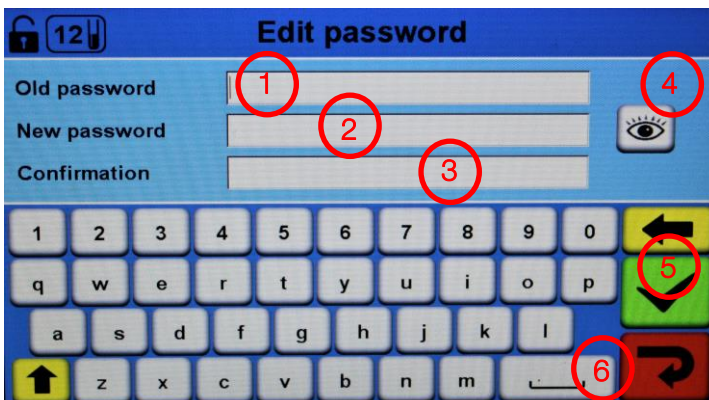

1. insert old password [Login]
2. insert new password [Login]
3. repeat new password to confirm [Login]
4. show / hide passwords verbergen [Login]
5. accept changes [Login]
6. discard changes and return to settings [Login]

8.6 Service menu

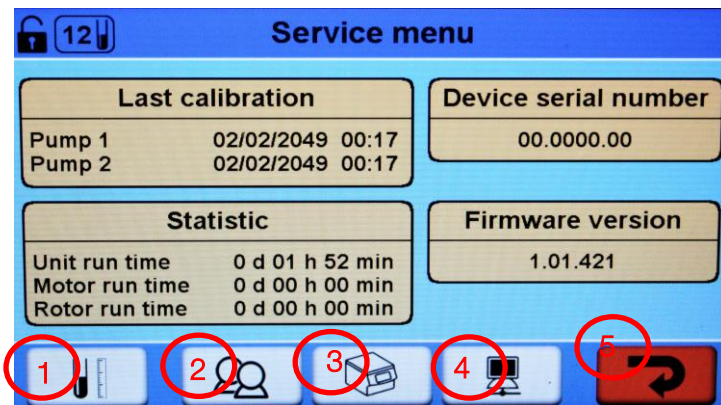

1. calibration [Login]
2. user settings [Login]
3. device settings [Login]
4. network settings [Login]
5. back to system settings [Login]

8.6.1 Calibration

Screen 1

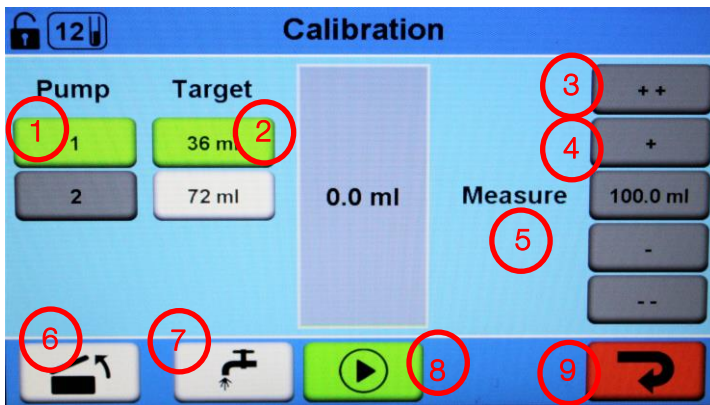

1. select pump [Login]
2. select target for measurement [Login]
3. correct by 1ml [Login]
4. correct by 0.1ml [Login]
5. target measure [Login]
6. open lid [Login]
7. fill in solution
8. start calibration
9. back to service menu without calibration

Screen 2

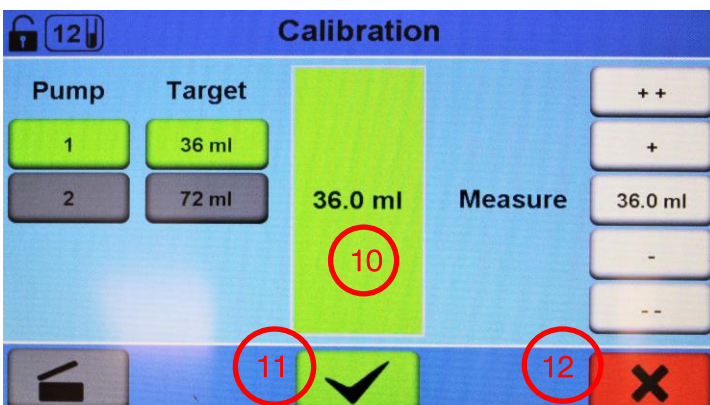

10. indicate filling level [Login]
11. accept and save the calibration
12. discard calibration

8.6.2 User settings

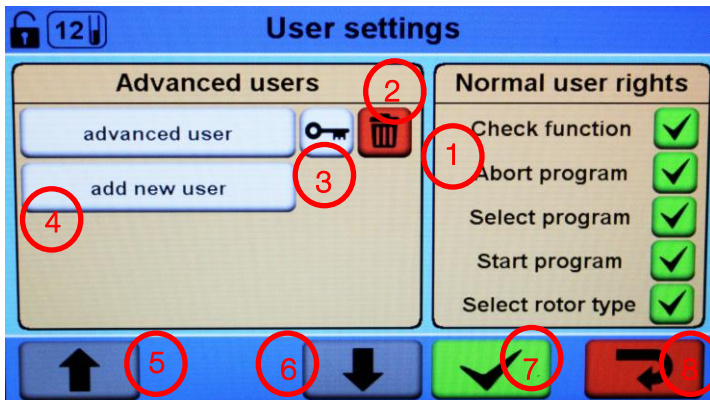

1. select / deselect user rights [Login]
2. delete user [Login]
3. set password [Login]
4. add a new user [Login]
5. go upward in user list [Login]
6. go downward in user list [Login]
7. save users [Login]
8. back to service menu without saving [Login]



Only the “service user” can generate a new “advanced user” and restrict or change the rights of the “normal user” account (without a login), e. g. change the green “tick” to a red “X” so that the “normal user” account cannot select the “Check” button during a run.



The password for the “advanced user” is “1008” and should be personalized accordingly during installation. The “advanced user” does not have access to the device settings and the calibration menu.

8.6.3 Device settings

Screen 1

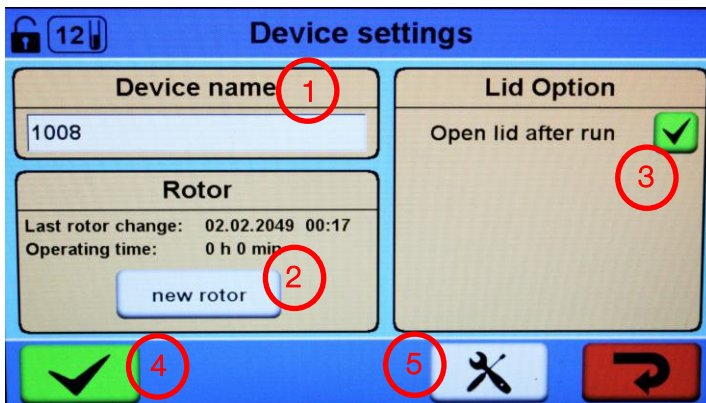

1. change device name [Login]
2. use new rotor [Login]
3. open the lid at the end of a run [Login]
4. save changes [Login]
5. go to second screen [Login]



Do not confuse the lid option with the „CHECK-process. By activating the lid option, the device will open the lid after every finished run or if an error occurs.

Screen 2

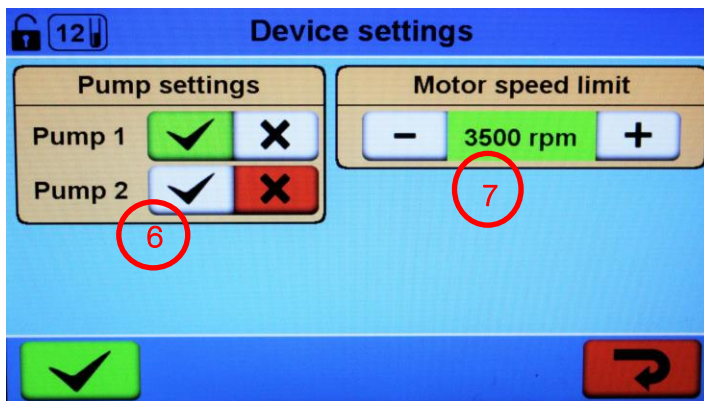

6. activate / deactivate pump [Login]
7. define motor speed limit [Login]



Factory setting: pump 1 = on, pump 2 = off, motor speed limit = 3500rpm, device name = 1008 (or 1008 03), rotor = the date corresponds to the manufacturer's end-control.

8.6.4 Network settings

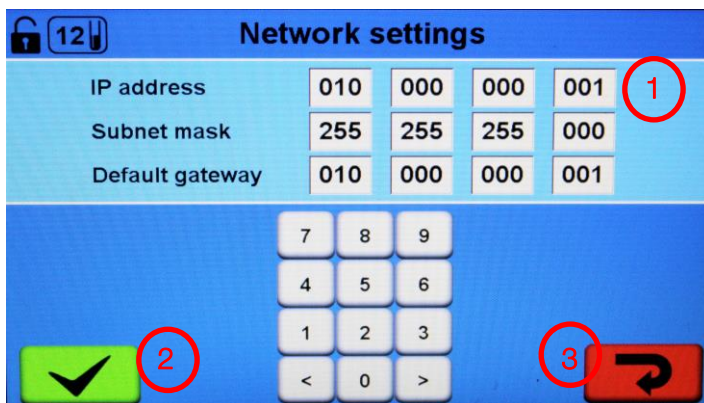

1. current network settings [Login]
2. save changes [Login]
3. back to service menu without saving [Login]

9 Programs

9.1 Validation

Validation of the device before use is strongly recommended, e.g., by the BCSH (=British committee for Standards in Haematology), the AABB (=American Association of Blood Bank), the guideline for the collection of blood and blood components of the German Medical Association.

9.2 Starting the program

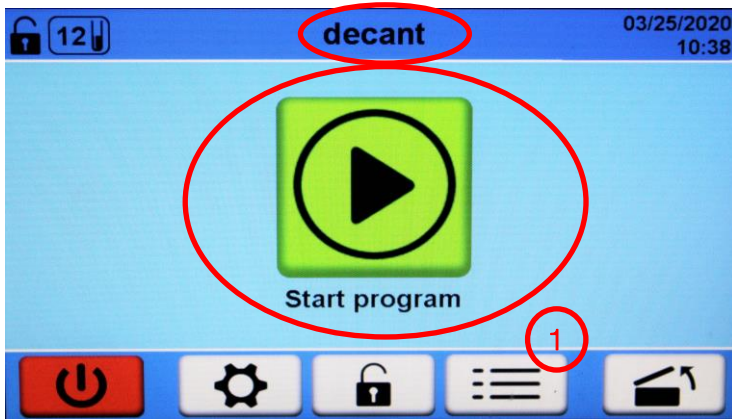

Start screen:

„decant“ is the actual loaded program.

Push „Start program“, to start.

1. Push this button to select a different program



Select a program.

To add a new program see chapter 8.4.



Each program must be validated by the user with the custom tube. If the tube is changed, then the program must be revalidated!



After selecting the program each process is displayed.



Check the program and all settings For each process!



To load the program push:



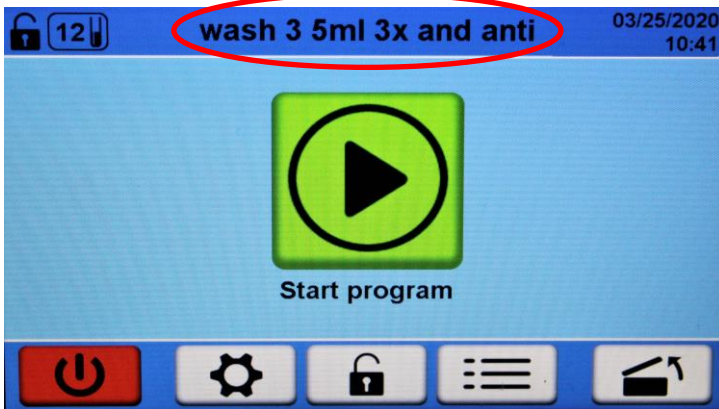

The now loaded program name is displayed.

Push „Start program“ to start.



The program starts and the ongoing process is highlighted.

Push „CHECK“ and the lid will open as soon as the ongoing process is finished.

9.3 Stop a running program



To stop the program, push „STOP“.

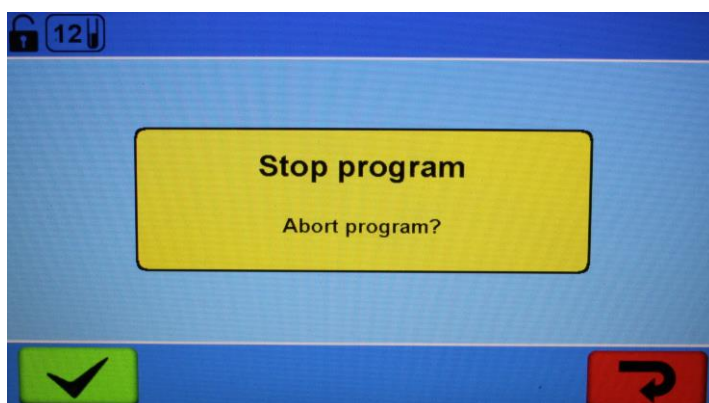

Confirm with:



Back with:



9.4 Pre-installed programs



1. Pre-installed system programs
2. Pre-installed user programs for the device types 1008-00

Pre-installed user programs only for the device type 1008-00S:

- cell recovery
- immunophenotyping

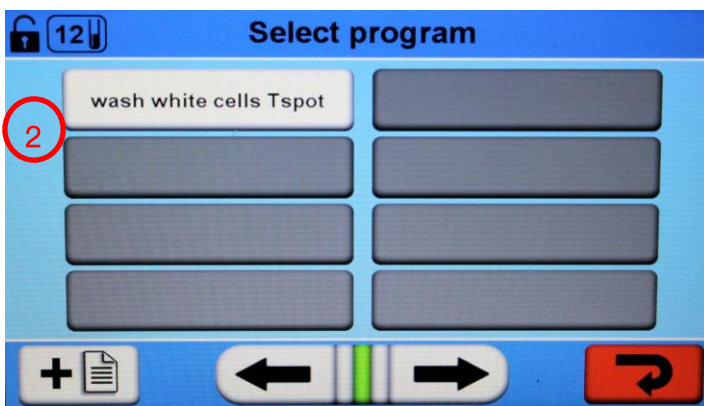

9.4.1 flush

This pre-installed system program is designed to flush (clean) the external and the internal tubing system with deionized or demineralized water after the routine so no salt crystals are built.

 Before the routine, the tube system must be rinsed with saline.
If you delete this program, only a specialist can reload it.

9.4.2 refill pump

This pre-installed system program is designed to refill the external and the internal tubing system with the used and needed solution without spinning the rotor. It will also ignore air bubbles in the system.

 If you delete this program, only a specialist can reload it.

9.4.3 wash redcells 3 5ml 3x (wash erythrocytes, 3.5 ml, 3 x)

This preinstalled program is visualized as an example.

The process values are:

- FILL 3.5ml 1100rpm (fill with 3.5 ml by 1100rpm)
- SPIN 20sec 3500rpm (acceleration 800rpm/s), braking 1000rpm/s)
- DECANT 390rpm (decant by 390rpm)
- AGIT 15x (15 agitations)
- LOOP 3x (two more runs, a total of three wash cycles)

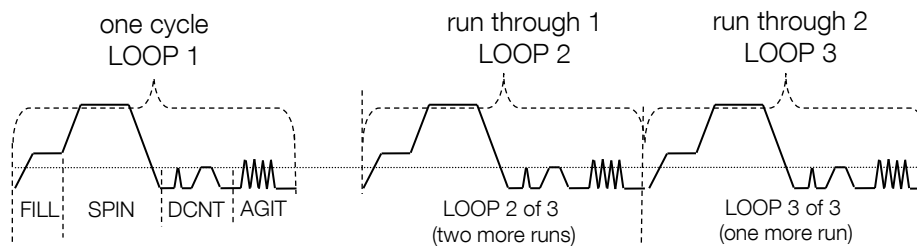

9.4.4 agit and spin

The process values are:

- AGIT 15x (15 agitations)
- SPIN 20sec 3500rpm (acceleration 800rpm/s, braking 1000rpm/s)

9.4.5 decant

The process values are:

- DECANT 390 rpm (decant by 390rpm)

9.4.6 spin 20sec 3500rpm

The process values are:

- SPIN 20sec 3500rpm (acceleration 800rpm/s, braking 1000rpm/s)

9.4.7 susp 3 5ml spin 20sec (centrifuge 3.5ml suspension for 20sec)

The process values are:

- FILL 3.5ml 1100rpm (fill 3.5 ml at 1100rpm)
- SPIN 20sec 3500rpm (acceleration 800rpm/s, braking 1000rpm/s)

9.4.8 wash 3 5ml 3x and anti (wash 3.5 ml, 3 x, plus antihuman globulin test)

The process values are:

- FILL 3.5ml 1100rpm (fill 3.5ml by 1100rpm)
- SPIN 20sec 3500rpm (acceleration 800rpm/s, braking 1000rpm/s)
- DECANT 390rpm (decant by 390rpm)
- AGIT 15x (15 agitations)
- LOOP 3x (two more runs)
- CHECK Pause (to add the antihuman globulin manually)
-
- SPIN 20sec 3500rpm (acceleration 800rpm/s, braking 1000rpm/s)

9.4.9 wash white cells Tspot (wash leukocytes, Tspot)

The process values are:

- FILL 2.5ml 900rpm (fill 2.5ml by 900rpm)
- SPIN 7min 2260rpm (acceleration 800rpm/s, braking 1000rpm/s)
- DECANT 370rpm (decant by 370rpm)
- AGIT 100x (100 agitations)
- LOOP 2x (only one more run)

9.4.10 cell recovery (only device type 1008-00S)

The process values are:

- FILL 2.0ml 1100rpm (fill 2.0ml by 1100rpm)
- SPIN 4min 2260rpm (acceleration 800rpm/s, braking 1000rpm/s)
- DECANT 370rpm (decant by 370rpm)
- AGIT 50x (50 agitations)
- LOOP 2x (only one more run)
- FILL 2.6ml 1100rpm (fill 2.6ml by 1100rpm)

9.4.11 immunophenotyping (only device type 1008-00S)

The process values are:

- FILL 1.5ml 1100rpm (fill 1.5ml by 1100rpm)
- SPIN 5min 1850rpm (acceleration 800rpm/s, braking 1000rpm/s)
- DOWN 1100rpm
- DECANT 370rpm (decant by 370rpm)
- AGIT 15x (15 agitations)
- LOOP 2x (only one more run)
- FILL 0.5ml 1100rpm (fill 0,5ml by 1100rpm)

9.5 Process descriptions

9.5.1 Principle

A program can have a maximum of 20 different processes, but only 1 LOOP process. It does not matter with which process a program starts, except with a LOOP process or a CHECK process and it can contain only 1 LOOP process.

9.5.2 FILL 1 process

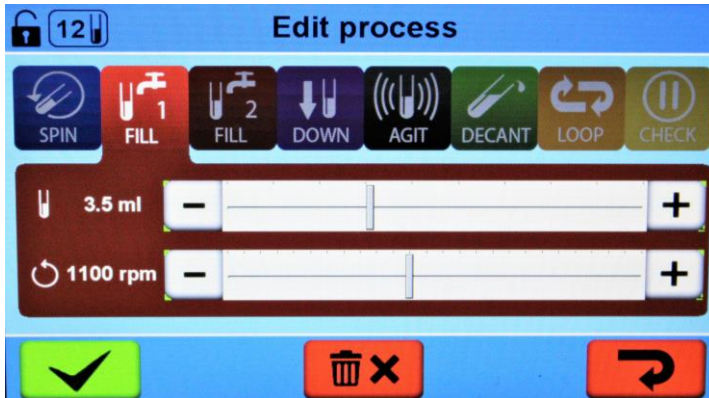

Add the physiological saline directly into the tubes via the distributor of the rotating rotor to get a good resuspension of the cells. For this purpose, a speed range from 0 rpm to 2500 rpm is available. The fill volume to be set per tube is between 0.1 ml and 10 ml. The default value is 3.5 ml at 1100 rpm.



The best centrifugation results are with a speed of 1100 rpm for both kinds of rotor types. The device will calculate the complete volume itself for the preselected rotor.

9.5.3 FILL 2 process



Filling in the secondary solution. For this purpose, a speed range from 0 rpm to 2500 rpm is available. The fill volume to be set per tube is between 0.1 ml and 10 ml. The default value is 3.5 ml at 1100 rpm.



Only selectable if your device has installed the optional second pump (part number 1008-02 and 1008-04)

9.5.4 DOWN process



Down:

The number of revolutions per minute is adjustable from 0 rpm to 3500 rpm. The time duration is adjustable from 0 s to 20 s. The default value is 2000 rpm and 5 s.

Centrifugation run to centrifuge the remaining droplets on the inner-side of the tubes to the bottom of the tube.

9.5.5 SPIN process

Page 1/2



Sedimentation:

The number of revolutions per minute is adjustable from 0 rpm to 3500 rpm. The time duration is adjustable from one second to two hours (0:00:01 to 2:00:00). The default value is 3500 rpm and 30 seconds (0:00:30)

The erythrocytes are sedimented by a selectable rotation speed. The time only begins to count after the set rotation speed is reached. After the time has elapsed, a quick braking follows to prevent a resuspension of the pellet.

Page 2/2



The default value for the acceleration is 800 rpm/s. The default value for the braking is 1000 rpm/s.

For the page change press onto the SPIN-icon



It is not possible to work with an endless spin process.

If it is necessary to work with a longer single spin process, it is possible to add a loop process for the desired time-duration of max. 200 hours (with more processes to an absolute maximum of 3800 h)

9.5.6 DECANT process

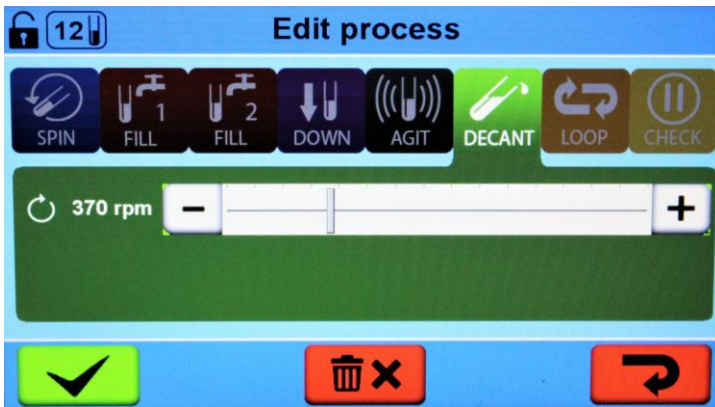

Decanting:

The number of revolutions per minute is adjustable from 0 rpm to 2500 rpm. The excess is decanted at the selectable rotation speed. During decanting, the rotor turns in the opposite direction of the normal rotation so that the solution will be decanted. The default-value is 370 rpm.



The correct speed must be validated with the used tubes for the best possible Decanting results because the different inner surfaces of the tubes, e.g., glass tubes or plastic tubes. You will also get different results when the speed is optimized for 10mm tubes but the used tubes are 12mm tubes.



If the DECANT speed is too high then it is possible that the washed cells will also be decanted. If the speed is too low, you will probably have too much liquid in the tubes and with the next FILL process the tubes will be overfilled.

9.5.7 AGIT process

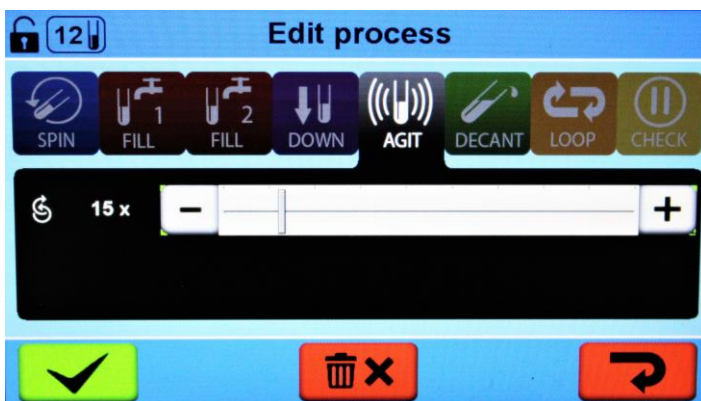

Agitating, shaking:

The numbers of shakings are adjustable from 0x to 500x. The default value is 15x. The pellet is loosened again for the subsequent wash cycle by a fast, brief movement of the rotor and the tube holders.

9.5.8 LOOP process

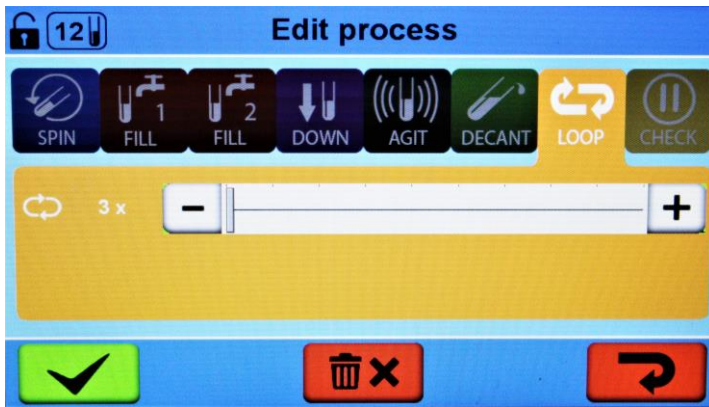

Loop.

This process only makes sense as a following process from a minimum of one other process. The numbers of loops are adjustable from 1x to 100x. The default value is 3x. After the foregone process is finished, all foregone processes will be repeated with the adjustable value minus 1.



If the foregone process is a spin process with a duration time of 2 hours and the loop process is adjusted to 2x, then the program will repeat the spin process once with a duration of 2 hours, which means that the device spins for 4 hours.



After the LOOP process you can add every other process except a LOOP process, that means you can program to wash out cells with two cycles instead of three with a DECANT process with a speed of approx. 320 rpm. With this speed a small amount of solution will stray into the tubes and after the LOOP process you add the same processes again, but the speed from the DECANT process is around 370 rpm; with this the tubes have the solution emptied.

9.5.9 CHECK process

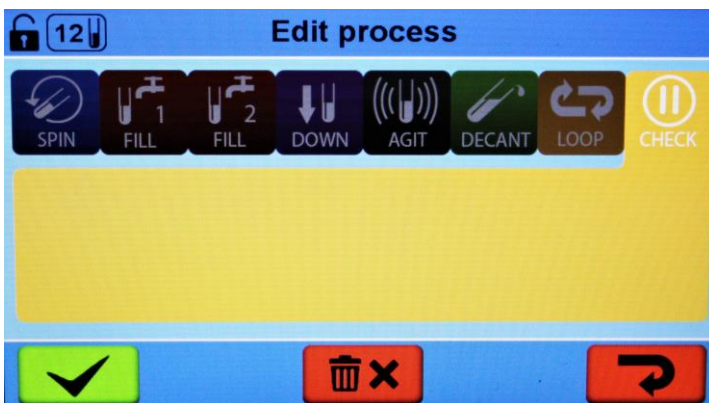

Check, pause:

This process only makes sense as a following process from a minimum of one other process. After the foregone process is finished the program will be paused and the lid will open. The user can check the probes or can add some other fluids to the probes with a pipette. When the lid is closed, the program will continue.



If the foregone processes is a wash cycle and you added the anti human globulin serum during the check process, the following processes are necessary: AGIT-process or SPIN-process.

9.6 Add a new program

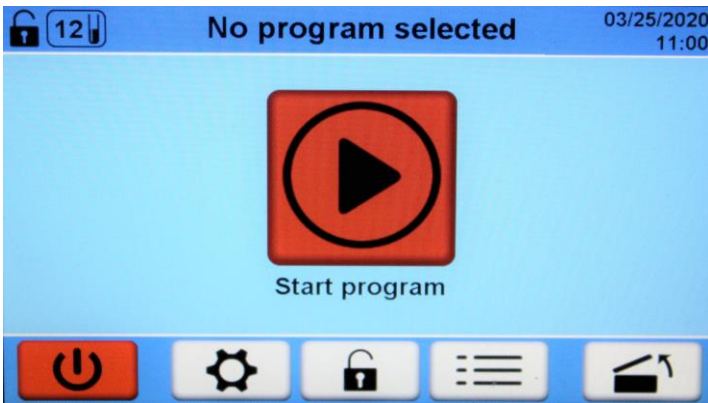

Go to the signs on the right:

- To select a program push:
- To add a new program push:

Only with login as an authorized user [Login]

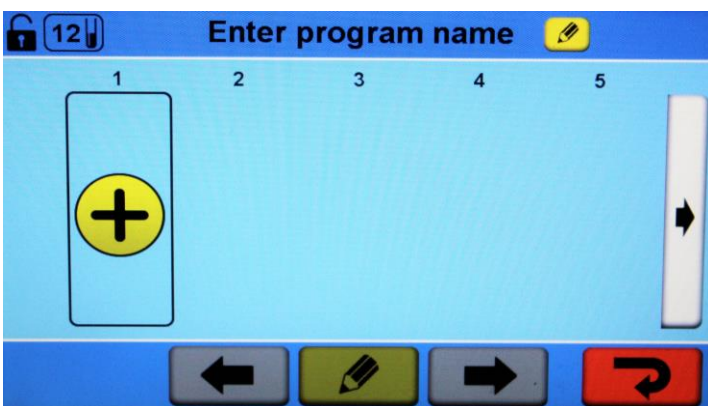

- To add the first process push:

- To edit the name push at the top:

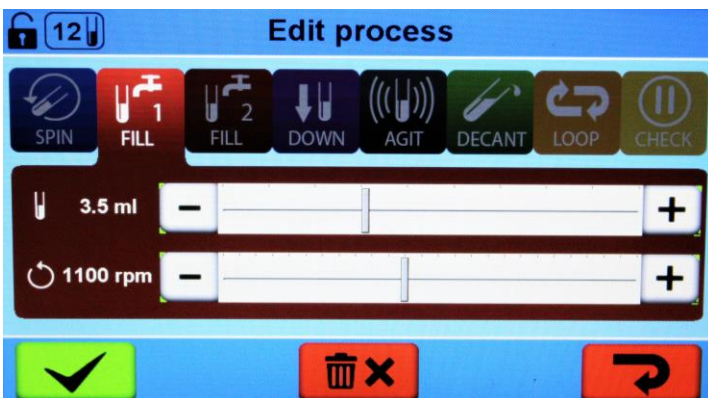

In this example, the first process is "FILL"

- Push the „FILL 1“ symbol
- Below the symbol you can choose the filling capacity and the rotation speed at which it should be filled.

To accept the FILL 1 process push:

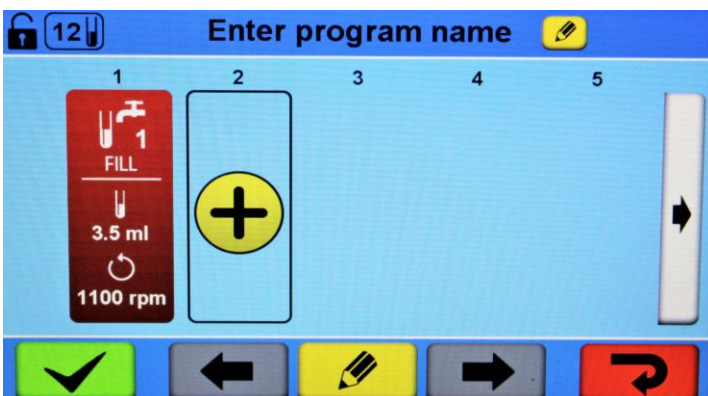

To add another process, click:

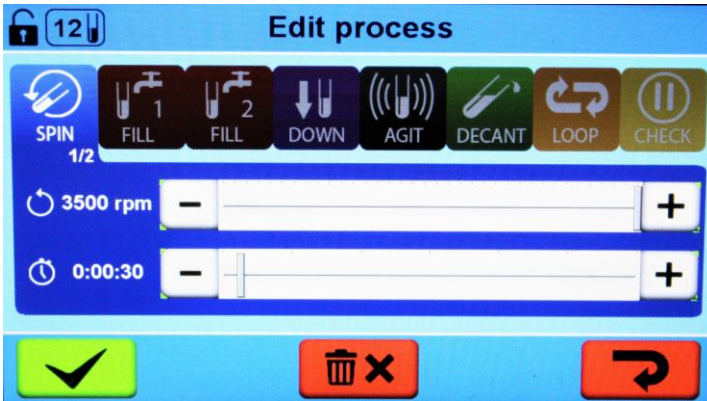



In this example, add the process "Spin":

- Push the „SPIN“ symbol
- Below the symbol you can choose rotation speed and the duration of the process. On the second page you find the acceleration- and braking speed by clicking:

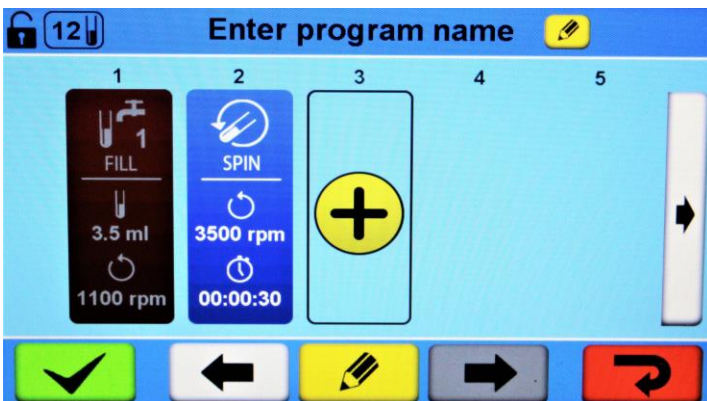

- To accept the SPIN process push: 



- To add more process push: 

- By selecting a process, you can switch the process to the previous process position

- To switch left push: 

- Or after the next process position to the right push:



- To edit a process select it and Push below:



- To save push: 

- to view processes 6 to 10, 11 to 15 and 16 to 20, push at the right side, backwards at the left side



Each program must be validated with a minimum of 12 probes with a 12-place rotor and equivalent 24 probes with a 24-place rotor and compared with another device or method.



If you change the used tubes, e.g. the size or from plastic style to glass style, or the supplier doesn't support the used tubes anymore, you must revalidate all used programs.

10 Adjusting

10.1 Entering the rotor type



It is necessary to enter the rotor type used (12-place or 24-place) in order to calculate the filling volume. It is only possible to enter the rotor type when the rotor has stopped.

To adjust settings:

- Go to system settings (start screen, cha. 8.2, pos. 4)
- Change to the actual used and inserted rotor type, 12-place or 24-place (cha. 8.5, pos. 8)
- Save the setting and go back to the start screen with the button save changes (cha. 8.5, pos. 6)

10.2 Calibrating the filling volume

- Go into the system settings (start screen, cha. 8.2, pos. 4)
- Go into the service menu (system settings, cha. 8.5, pos. 7)
- Go into calibration (service menu, cha. 8.6, pos. 1)
- Open the lid (cha. 8.6.1, pos. 6)
- Check that the 36ml target is green for the use of a 50ml graduated measuring cylinder, conform to DIN/EN/ISO 4788 and equivalent for the 72ml target for a 100ml cylinder.
- Remove the rotor and hold a cup underneath the injection tube and push the button fill in solution (cha. 8.6.1, pos. 7) and ensure that no air bubbles are in the solution tube at the back side of the lid (fig.7.1, pos. 1)
- hold a cylinder underneath the injection tube inside from the lid and push the button start calibration (cha. 8.6.1, pos.8)
- Adjust the reading from the cylinder at the target measure (cha. 8.6.1, pos. 10) with the buttons “+” or “-” graduate decimal point 0.1ml and “++” or equivalent “- -” graduate decimal point 1ml.
- Accept the calibration (cha. 8.6.1, pos. 11) or discard the calibration (cha. 8.6.1, pos. 12)
- If it was necessary to adjust the calibration, then check the calibration again.
- Exit with the button go back to the service menu (cha. 8.6.1, pos. 9)



Do a calibration check:

- Weekly
- Before a validation
- After maintenance

10.3 Audible signal

The following audible signals are programmed:

- 2 second intervals if an error occurs
- in 10 second intervals after the program has ended and the rotor has stopped.
- The audible signal can be stopped by opening the lid or by pushing any button.
- The signal after completion of the program can be activated or deactivated in the following manner, if the rotor is at standstill:
 - To adjust the volume, go at the start screen and push the button for the system settings (cha. 8.2, pos. 4)
 - Adjust the volume by varying the slider at the bar (cha. 8.5, pos. 5), at the far left side, the audible signal is deactivated.
 - Select your preferred mode for the audible signal after the program is ended with only one beep or with an endless interval of 10 seconds for one hour.
 - Confirm it with the button save changes (cha. 8.5, pos. 6).



If an alarm or the program end beep is running then the standby mode will activate till after 60 minutes instead of the normal 10 minutes, but the display will go to dark mode after 10 minutes instead of the normal 5 minutes.

10.4 Relative centrifugal force (RCF)

The relative centrifugal force (RCF) is given as a multiple of the acceleration of gravity (g). It is a unit-free value and serves to compare the separation and sedimentation performance.

These values are calculated using the formula below:

$$\text{RCF} = \left(\frac{\text{RPM}}{1000} \right)^2 \times r \times 1,118 \quad \Rightarrow \quad \text{RPM} = \sqrt{\frac{\text{RCF}}{r \times 1,118}} \times 1000$$

RCF = relative centrifugal force

RPM = rotational speed (revolutions per minute)

r = centrifugal radius in mm = distance from the centre of the turning axis to the bottom of the tube, see cha. 16.1, Rotors and accessories.



The relative centrifugal force (RCF) stands in relation to the revolutions per minute and the centrifugal radius.



10.5 Querying operating hours

Go into the system settings (start screen, cha. 8.2, pos. 4)

Go into the service menu (system settings, cha. 8.5, pos. 7)

11 Maintenance and servicing

 	The device can be contaminated.
---	---------------------------------

 	<p>Pull the mains plug before cleaning.</p> <p>For safety reasons, you must wear gloves and a respiratory mask when cleaning the equipment used for blood processing.</p> <p>Before any other cleaning or decontamination process other than that recommended by the manufacturer is applied, the user has to check with the manufacturer that the planned process does not damage the device.</p>
---	--

- Centrifuges, rotors and accessories must not be cleaned in rinsing machines.
- They may only be cleaned by hand and disinfected with liquids.
- The water temperature must be between 20 – 25°C, 68°F – 77°F.
- Only detergents/disinfectants may be used which:
 - have a pH between 5 - 8
 - do not contain caustic alkalis, peroxides, chlorine compounds, acids and alkaline solutions
- To prevent appearances of corrosion through cleaning agents or disinfectants, the application guide from the manufacturer of the cleaning agent or disinfectant must be heeded.
- Certain preservation agents in acid-free saline solutions can cause long-term damage to the plastic parts in the device. Regular cleaning prevents salt deposits and lengthens the life span of these parts.

11.1 Centrifuge

- The following must be carried out daily:
 - Check the tubes and their attachments. The tubes must not be cracked or blocked and must be securely attached. Do not forget the solution tube to the lid (fig. 7.1, pos. 1). The used saline solution must be allowed to flow off freely through the drainage hose.
 - The centrifugal area must be clean and free from dried up salt crystals and other deposits. Clean the centrifugation area, the splash guard receiver and the splash guard cap with a moist cloth or sponge. The splash guard receiver and the covering ring can be removed from the centrifugation area for cleaning, refer to Chapter "Removal of the splash guard receiver and cap".
 - Check the filling volume of the saline solution container
 - The system must be rinsed through with distilled water to avoid formation of salt crystals, refer to Chapter "12.5 Flushing system with deionised or distilled water".
- It is important that the tubes are kept clean and free from dried up salt crystals and other deposits.
- The system must be regularly cleaned, refer to Chapter "**Fehler! Verweisquelle konnte nicht gefunden werden.**". It is recommended to clean the appliance at least once a week.
- Clean the centrifuge housing and the centrifuging chamber regularly, using soap or a mild detergent and a damp cloth if required. This serves as hygiene protection and prevents corrosion caused by impurities.
- Ingredients of suitable detergents:
 - soap, anionic tensides, non-ionic tensides.
- After using detergents, remove the detergent residue by wiping with a damp cloth.
- The surfaces must be dried immediately after cleaning.
- Lightly rub the rubber seal of the centrifuge chamber with talcum powder or a rubber care product after each cleaning.
- Surface disinfection:
 - If infectious materials penetrate the centrifugal chamber this is to be disinfected immediately.
 - Ingredients of suitable disinfectants:
 - ethanol, n-propanol, isopropyl alcohol, glutardialdehyde, quaternary ammonium compounds.
 - After using disinfectants, remove the disinfectant residue by wiping with a damp cloth.
 - The surfaces must be dried immediately after disinfecting.
- Removal of radioactive contaminants:

- The agent must be specifically labelled as being an agent for removing radioactive contaminants.
- Ingredients of suitable agents for removing radioactive contaminants:
anionic tensides, non-ionic tensides, polyhydrated ethanol.
- After removing the radioactive contaminants, remove the agent residue by wiping with a damp cloth.
- The surfaces must be dried directly after removing the radioactive contaminants.
- The centrifuging chamber is to be checked for damage monthly and after glass breakage
- If the lid not stops wherever it will be released, then notify the Customer Service to replace both hinge together



If damage is found which is relevant to safety, the centrifuge may no longer be put into operation. In this case, notify Customer Service.

11.2 Rotor

- It is important that the rotor is kept clean and free from dried up salt crystals and other deposits.
- Either soak the rotor in warm, distilled water or pour the water directly down into the rotor for a few minutes. The water must flow out of all the injection nozzles.
- If the injection nozzles are blocked, insert the included plastic pin into the injection nozzles and carefully slide it in and out until the nozzles become clear again.
- In order to prevent corrosion and material changes, rotors and accessories must be cleaned regularly with soap or a mild detergent and a damp cloth. Cleaning is recommended at least once a week. Contaminants must be removed immediately. Ingredients of suitable detergents:
soap, anionic tenside, non-ionic tenside.
- After using detergents, remove detergent residue by rinsing with water (only outside of the centrifuge) or wipe off with a damp cloth.
- The rotors and accessories must be dried directly after cleaning.
- Disinfection:
 - If infectious material should get on the rotors or accessories, they must be appropriately disinfected.
 - Ingredients of suitable disinfectants:
glutaraldehyde, propanol, ethyl hexanol, anionic tenside, corrosion inhibitors.
 - After using disinfectants, remove disinfectant residue by rinsing with water (only outside of the centrifuge) or
or
 - wipe off with a damp cloth.
 - The rotors and accessories must be dried directly after disinfection.
 - Removal of radioactive contaminants:
 - The agent must be specifically labelled as being an agent for the removal of radioactive contaminants.
 - Ingredients of suitable agents for removing radioactive contaminants:
anionic tenside, non-ionic tenside, polyhydrated ethanol.
 - After removing the radioactive contaminants, remove agent residue by rinsing with water (only outside of the centrifuge) or wipe off with a damp cloth.
 - The rotors and accessories must be dried directly after removing the radioactive contaminants.
 - The rotor is to be checked for corrosion damage every month. The rotor is to be checked for corrosion damage every month.



If there are signs of wearing or corrosion, e.g. cracks in the material, the rotors and accessories must no longer be used.

11.3 Autoclaving



The system must be regularly disinfected and cleaned, refer to Chapter 12.6 Clean system. No parts from the device and its accessories are made for autoclaving.

11.4 Removal of the splash guard receiver and cap

The splash guard receiver and the splash guard cap can be removed from the bowl (fig. 7.5), centrifugation area, (fig. 7.5), for cleaning.

Removal of the splash guard receiver and the splash guard cap:

- Remove the splash guard cap (fig. 7.5) from the bowl (fig. 7.5)
- Carefully flap the inner sealing ring (fig. 7.5) upwards and remove the splash guard receiver (fig. 7.5) out of the centrifugation area.

Installation of the splash guard receiver and splash guard cap:

- At the back of the centrifugation area carefully flap the sealing ring (fig. 7.5,) upwards and push the splash guard receiver (fig. 7.5) under the sealing ring (fig. 7.5)
The drain hole of the splash guard receiver must be located above the drain hole in the bowl
- Carefully flap the sealing ring upwards around the splash guard receiver on the inside and press the splash guard receiver carefully downwards. The splash guard receiver (fig. 7.5) must be located below the sealing ring (fig. 7.5).
- Place the splash guard cap (fig. 7.5) onto the splash guard receiver in such a way that the inscription "this side up" can be read, refer to fig. 7.5 (in red)

11.5 Flushing the system with deionized or distilled water

- Take off the saline-tube, solution 1, from the physiological saline solution container and dip it into the provided flask with deionized or distilled water
- Start the system-program "flush"
- Take off the saline tube from the flask and dip it back into the saline solution container
- Open the lid and dry the centrifuging area



Keep the deionized or distilled water in the system until you start with the next wash procedure to protect the system from crystallized salt crystals.



Take care to rinse the system with the flush-program before starting any other program, otherwise the probes will be disturbed.

11.6 Cleaning the system with cleaning solution

- In a beaker, prepare about 400ml of 0.5% sodium hypochlorite cleaning solution, also prepare deionized or distilled water in a flask
- Take off the saline tube, solution 1 from the physiological saline solution container and dip it into the beaker with the 0.5% sodium hypochlorite cleaning solution
- Start the system-program "flush"
- Wait 5 minutes
- Take off the saline tube from the beaker and dip it into the flask with deionized or distilled water
- Start the system-program "flush"
- Open the lid and dry the centrifuging area
- Take off the saline tube from the flask and dip it into the saline solution container
- Start the system program "flush"
- Check the filling volume by doing the procedure "10.2 calibrating the filling volume"

- Take off the saline tube from the saline solution container and dip it into the flask with deionized or distilled water
- Start the system program “flush”
- Keep the deionized or distilled water in the system until you start with the next wash procedure and take care to rinse the system with the flush program before starting any other program

11.7 Glas breakage

In a case of glass breakage, the pieces of glass and leaked centrifugal liquid must be carefully removed from the centrifugal area and tube holders.



The leakage could involve infectious materials, the area must be disinfected immediately. The drain hole from the bowl should be blocked, for example, with a plug, pencil rubber or with a crimped over tissue, so that no pieces of glass can fall into the drain-hole and block the drain outlet connector on the rear side of the device, fig. 7.1, pos. 9, before starting to remove all broken pieces of glass.



Before continuing to work:

- The bowl must be checked for scratches, if present a technician must replace it => call your local distributor.
- The tube holder, where a tube was broken must be replaced, the rotor and its tube holders must be checked for scratches and the rotor must be checked for correct function, if so or you are unable to resolve that, then the rotor must be replaced.



Take care never to use tubes which

- have fallen to the floor
- have cracks in the glass

11.8 Repairs



Repairs and periodic maintenances of the device (internally where it is necessary to open the case) must be done **ONLY** by the manufacturer's authorised employees. **ONLY** original parts, authorised by the manufacturer, must be used for repair

11.9 Rotor crash

WARNING In a case of a rotor crash you must immediately contact the manufacturer or your local service support to ask for instructions before you touch the device or some piece of it.



If you cannot reach somebody, then take pictures from different views and you are allowed to inject the device and the surrounding area with a disinfectant, but not anything else!

11.10 Maintenance schedule

Recommended minimum requirements. Regulations for your organization or physical conditions at your organization may require maintenance items to be performed more frequently and or only by designated service personnel.

Task	Frequency			
	daily	weekly	monthly	annually
Inspect the tubing and drain and clear obstructions if necessary	X			
Inspect the tubing connections and secure them if necessary	X			
Flush the system with deionized or distilled water	X			
Clean and dry the interior after normal usage to prevent corrosion and contamination	X			
Flush the system with cleaning solution		X		
Clean the fill ports on the rotor		X		
Check the saline volume setting and calibrate it if necessary. Frequency varies by length of service		X		
Check the rotor speed and calibrate it if necessary				X
Inspect the rotor for wear, corrosion, and damage Replace the rotor if these conditions exist			X	
Inspect the tube holders for wear and damage Replace tube holders if they are worn or damaged, or after they have been in use for two years			X	
Clean the exterior		X		
Replace the supply and drain tubing				X
Replace the tube holder inserts for 10 mm x 75 mm tubes				X



Replace the tube holders every two years
Replace the rotor, every four years (including the tube holders)

12 Faults and errors

12.1 Operator faults

Fault	Cause	Remedy
Incomplete wash cycle	<ul style="list-style-type: none"> • A 24-place rotor is being used, even though a 12-place rotor has been set as the rotor type. • The filling volume is set too low. • The injection nozzles are blocked. 	<ul style="list-style-type: none"> • Check the rotor parameter in the system settings. • Check the volume (ml) and speed from the FILL-process in the used program. • Clean the injection nozzles.
Pellet does not form on the base of used tube	<ul style="list-style-type: none"> • The revolutions per minute during the centrifugation run for the agglutination test are too low. • The tube holders are left hanging in the decantation position • Wrong tube type 	<ul style="list-style-type: none"> • Check the spin process from the used program. • Check the rotor functions. • Check if the used tube is the same as during the program validation
No pellet/pellet too small	<ul style="list-style-type: none"> • A 12-place rotor is being used, even though a 24-place rotor has been set as the rotor type. • The filling volume is set too high. • Wrong tube type 	<ul style="list-style-type: none"> • Check the rotor parameter in the program. • Check the saline (ml) parameter in the program. • Check if the used tube is the same as during the program-validation.
The liquid is not decanted.	<ul style="list-style-type: none"> • The rotor mechanism is defective. • The revolutions per minute during the DECANT-process are too low. 	<ul style="list-style-type: none"> • Check the rotor functions • Check the DECANT-process from the used program.



If you detect a variable fill volume over a tolerance of $\pm 15\%$ of the setting, then you must check the fill port from the rotor and if necessary, you must clean or exchange it.

12.2 Software error codes

Error Code	Error Name	Description	Possible reasons
0	No error	Program was successful, no error has occurred	
1	Running	Program is still running, so far no error has been detected (should never be visible in history)	
Motor error			
10	Motor startup error	Motor could not be started (no speed could be detected)	<ul style="list-style-type: none"> • Motor is blocked • Motor cable connection problem • Motor power supply problem
11	Motor acceleration error	Motor could not accelerate within tolerance (motor was too slow)	<ul style="list-style-type: none"> • Wrong rotor type selected • Mechanical friction too big
12	Motor acceleration error	Motor could not accelerate within tolerance (motor was too fast)	<ul style="list-style-type: none"> • Wrong rotor type selected
13	Motor speed error	Motor could not hold the desired speed (motor was too slow)	<ul style="list-style-type: none"> • Wrong rotor type selected • Maximum of motor speed limit too high (4000 rpm can maybe not be hold) • Motor speed control does not work as intended • Motor speed reading failure
14	Motor speed error	Motor could not hold the desired speed (motor was too fast)	<ul style="list-style-type: none"> • Motor speed control does not work as intended • Motor speed reading failure
15	Motor brake error	Motor could not slow down within tolerance	<ul style="list-style-type: none"> • Wrong rotor type selected
16	Motor internal error	Motor has signaled an error	<ul style="list-style-type: none"> • Motor blocked • Motor over temperature • Motor power supply error
17	Motor power supply	The 24 V of the motor supply is not available	<ul style="list-style-type: none"> • Lid is detected as open
Liquid injection system error			
20	Pump error	Pump was not able to pump the desired amount of liquid	<ul style="list-style-type: none"> • Pipe blocked • Pump not working • Flow sensor not working
21	Liquid container empty	Not enough liquid available or air is in the pipe	<ul style="list-style-type: none"> • Liquid container empty • Air in the pipe • Flow sensor problem
Lid error			
30	Lid blocked	Open or check button was pressed, but the lid could not be opened.	<ul style="list-style-type: none"> • Lid mechanically blocked
31	Unlocking failed	Open or "CHECK" button was pressed, but the lock could not be unlocked.	<ul style="list-style-type: none"> • Motor was still rotating at the time the command for unlocking was received • Problem with the lock
32	Unexpected unlocking	Lid was opened without a request.	<ul style="list-style-type: none"> • Emergency unlocking was used

33	Lid detection failure	Lid sensor has detected an opening of the lid, but the lock sensor still signalizes the lock is closed	<ul style="list-style-type: none"> • Wrong lid detection of the lid sensor • Wrong lock detection of the lock sensor
System error			
40	Program reading error	It was not possible to read the complete program.	<ul style="list-style-type: none"> • Program file is corrupted • Not enough dynamic memory was available
41	Image loading failed	Not all images could be loaded	<ul style="list-style-type: none"> • An image is missing on the flash • An image on the flash is corrupted
42	EEPROM-error	Loading data from EEPROM failed. (reading not possible or checksum for the data is incorrect)	<ul style="list-style-type: none"> • EEPROM not initialized (login of a service user needed) • Communication failure
Miscellaneous			
50	Unknown	An error has occurred, but the kind of the error could not be identified	<ul style="list-style-type: none"> • Unexpected behavior
51	Program interrupted	A running program was interrupted	<ul style="list-style-type: none"> • Power interrupted during a running program.
52	Program aborted by user	The program was aborted by the user	<ul style="list-style-type: none"> • User has aborted the program
53	Imbalance	The program was stopped because of an imbalance of the rotor	<ul style="list-style-type: none"> • Rotor was not loaded symmetrically • Positioning of the imbalance sensor not correct



„Screen freeze:

If a screen freeze occurs, not the normal standby mode (push anywhere onto the dark display), perform a main reset



Perform a MAINS RESET:

- Switch off the mains switch (position "0", fig. 7.1, pos. 3).
- Wait at least 10 seconds and then switch on the mains switch again to position "1".
- Check the history for the last run and report the error code to your local service support



Before you open the lid with the release pin (cha. 4.3) you must check through the window into the lid that the rotor is at a standstill position



If it is not possible to close the lid => check if there is a small part that has fallen into the lid lock access hole (fig. 7.5), if so then contact your local service support

12.3 Changing the fuse



Switch off the mains switch and remove the power plug from the external power supply from the mains!

Screw the cap from the fuse holder, fig. 7.1, pos. 6, off by turning it counter-clockwise, 1/8-turn, and pull it out with the fuse. Exchange the defective fuse and tightly screw it including the cap back into the fuse holder by turning it in clockwise direction.



Only T10A/125VAC, 6.3 x 32 mm fuses with UL and CSA approval, (order no. UC.E114) cap, for fuse holder, 6.3 x 32 mm, (order no. UC.E104)
F10AA/250VAC, 5.0 x 20 mm fuses with UL and CSA approval, (order no. UC.E118) cap, for fuse holder, 5.0 x 20 mm, (order no. UC.E116) may be used.

13 Returning the device / parts of it



If the device, some parts of it or its accessories are returned to Hettich AG or the local supplier, to provide protection for people, the environment and materials, it must be decontaminated and cleaned before being shipped, a declaration should be apply to the device, and respectively to the parts.



Before returning the device, a transport securing part must be installed.
Before returning the device or some parts of it via some local suppliers, you should ask for an RMA-number (Return Authorization Number)



We reserve the right to refuse contaminated devices or accessories.
Costs incurred for cleaning and disinfection are to be charged to the customer.

14 Storage



Before storing the device, it should be decontaminated and cleaned to protect people, the environment and property. We suggest putting a declaration onto the device with the date, sign and the solution.

The appliance may only be stored under the following conditions:

- in an enclosed, dust-free room conform to the storage environment, refer to the tech. specifications (cha. 5, tab. 1)
- frost-free
- disconnected from the power supply
- If the storagetime is longer than 12 months, it's recommended to remove the battery on the controller-board

14.1 Disposal



Before disposal, the device must be decontaminated and cleaned to protect people, the environment and property. Please also observe all other regulations applicable in this context. We suggest applying a declaration to the device with the date, sign and the solution.



When you are disposing of the device, the respective statutory rules must be observed. Pursuant to guideline WEEE, all devices supplied after August 13, 2005 may not be disposed as part of domestic (household), or industrial waste. The device belongs to group 8 (medical devices) and is categorized in the business-to-business field. The icon of the crossed-out trash can show that the device may not be disposed as part of domestic waste. The waste disposal guidelines of the individual EC countries might vary. Contact your supplier or the local department for treatment of waste. There is a lithium battery in the main electronic-board of the device. Remove it and dispose of it in accordance with the regulations in your country.







Note for Germany:

The device may not be left at public or communal recycling or collection points. If necessary, contact your supplier or the local department for treatment of waste.

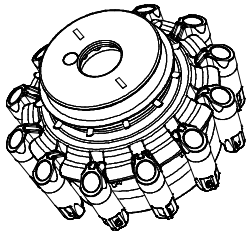
15 Appendix

15.1 Rotors and accessories

1017-A (for 1008-00) SM1012-A (for 1008-00S)	E2197						
Decant Rotor 12-Places  $\leq 45^\circ$							
	Adapter						
	1019 ¹⁾						
	Tubes						
							
	Capacity: ml	3	5				
Dimensions / Ø x L mm	10 x 75	12 x 75					
Number p. rotor	12	12					
Speed: RPM (U/min)	3500 ²⁾						
RZB / RCF:	1438						
Radius: mm	105						



¹⁾ 1019 = Set with 12 pieces

²⁾ max. speed 3500 rpm / 1438RCF => recheck with the supplier / distributor / manufacturer of the tubes







The rotor for the device type 1008-00S has the article number SM1012-A (without adapter)

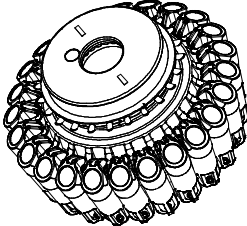

All tests carried out by Hettich AG were run with the following tubes:

Glas 12x75mm, Haslab, 9270106 and 10x75mm Haslab, 9270105 as well as 10.5x75mm, Milian, 041-VR-10575-75

1018-A (for 1008-00) SM1024-A (for 1008-00S)	E2197					
Dekantierrotor 24-fach / Decant Rotor 24-Places  $\angle 45^\circ$						
	Adapter					
	1019 ¹⁾					
						
	Tubes					
						
Capacity: ml	3	5				
Dimensions Ø x L: mm	10 x 75	12 x 75				
Number p. rotor:	24	24				
Speed: RPM (U/min)	3500 ²⁾					
RZB / RCF:	1438					
Radius: mm	105					



¹⁾ 1019 = Set with 12 pieces

²⁾ max. speed 3500rpm / 1438RCF => recheck with the supplier / distributor / manufacturer of the tubes



The rotor for the device type 1008-00S has the article number SM1012-A (without adapter)



All tests carried out by Hettich AG were run with the following tubes:

Glas 12x75mm, Haslab, 9270106 and 10x75mm Haslab, 9270105 as well as 10.5x75mm, Milian, 041-VR-10575-75

15.2 Spare parts

The following quantities are based on a recommendation from the manufacturer.

p / n	Description	> 5 units	> 25 units
E4259	plug, waste, for waste tube	X	
E4261	plug, Input 1, for saline tube	X	
E4260	Push-in plug, for emergency-release hole		X
E4258	weight for suction tube, INOX	X	
E4394	elbow nozzle, for drain-hose	X	
E4373	fill-hose, inlet 1, complete	X1	
E4374	waste-hose, drain-outlet, with connector	X1	
E4375	internal tube-set for periodic maintenance		X2
E2287-01	emergency-release pin		

1 = must be replaced after loan or demo.

2 = Should be replaced after loan or demo.

15.3 Document history

rev.	supersession	Revision description	created by
1.0	01 - 06	Template, Contents, desc. of preloaded programs	23.05.2017
1.1	1.0	Correction p/n from accessories, implementation of Document History	24.05.2017
1.2	1.1	Edit chapter 12, 13, new CE-declaration and correction of typing errors	04.06.2017
1.3	1.2	Edit chapter 12, new header	07.06.2017
1.4	1.3	Editing formatting and adding the actual declaration of conformity	04.09.2017
1.5	1.4	Editing of writing and orthographic errors	30.11.2017
1.6	1.5	Editing the address from the manufacturer	01.12.2017
1.7	1.6	Editing the LOOP-process	01.12.2017
1.8	1.7	Editing of orthographic errors, preinstalled programs, notes on safety, use according to the specifications and unpacking the centrifuge	22.01.2018
1.9	1.8	Description from the preinstalled programs, DECANT max value, error 15	16.08.2018
2.0	1.9	tech. data (Noise), chapter password protection inserted, CE declaration renewed	08.01.2019
2.1	2.0	Edit chapter 2. Paragraph two, 2.1 software-version, edit chapter 8.1 overview, edit chapter 8.5.2 language, date and time settings, edit chapter 9.3.3 to 9.3.9 acceleration and braking presetting, edit chapter 9.4.5 SPIN-process	11.03.2019
2.2	2.1	Add. of the type 1008-00S, Chap. 2 best use, Chap. 5 tech. data, Chap. 6.3 Article number and added pictures, , Chap. 7.1.1 added, Chap. 9.3, 9.3.10 & 9.3.11 Program and Rotor added for device 1008-00S, Document history adapted	07.11.2019
2.3	2.2	Cha. 12.5 and 12.1 fixed typing errors, revision of the document history	02.12.2019
2.4	2.3	adjusted footer, Date p. 2, Cha. 3 typing errors fixed, line inserted in chap. 7.2 (orthography), access rights corrected in Chap. 8.2 and 8.5.2, translation errors corrected in Chap. 8.3, 8.5 and 8.6.2, font adapted to CI in Chap. 8.6.1 and the following chapter relocated to the next page, numbers implemented in pictures for better understanding in chap. 9.3, translation error corrected in chap. 9.4.5 and moved to the following page, added to the article number table and the reduction note expanded for better comprehensibility	
2.5	2.4	Revision status corrected in footer, typing error fixed (all chapters), layout adapted (entire document), all images and tables inserted in EN and updated according to the latest software 421, image captions and descriptions, image references adjusted (entire document) chap. 5 Technical data, sound pressure level changed from 49 to 62dB, chap. 16.2 inserted (from service manual), Fig.7.6 (rotor) inserted, chap. 8.1 Overview menu navigation new picture inserted in DE, chap. 8.6.3 Lid option explained and extra picture inserted, 9.4.6 DECANT new wording, 10.2 Calibration changed from monthly to weekly, sentence positions and spellings changed (all chapters) Chap. 15 Remove storage battery inserted, chap. 16.1 Added information regarding glass tubes, removed operator-manual from list in Cha. 6.3	09.06.2020

2.6	2.5	<p>Removed everything about type 1008-03 from the entire instruction manual.</p> <p>Chapter 12.1, removed chapter reference to 10.2</p> <p>Chapter 2.1 & 8.1, 8.1.1, inserted firmware version 1.01.424</p> <p>Chapter 5, filling tolerance inserted and 12V car battery removed</p> <p>Chapter 8.3, inserted information about storage capacity of 24 programs</p> <p>Chapter 6, information that centrifuge was packaged under non-sterile conditions inserted</p> <p>Chapter 6.6 incl. picture added, marking (Nameplate)</p> <p>Title of cover sheet changed</p>	02.12.2021
2.7	2.6	<p>Chapter 2, resp. cleaning removed and replaced tuberculosis or tumor tests by tuberculosis tests</p> <p>Chapter 9.1 added</p> <p>Chapter 9.4.2, Results replaced by centrifugation results</p> <p>Chapter 9.4.6, Results replaced by decanting results</p> <p>Chapter 11, Centrifugation of materials or mixtures of materials with a density higher than 1.2 kg / dm³ removed</p> <p>Chapter 15.1, old tubes replaced by the newly tested tubes</p>	21.01.2022
2.8	2.7	<p>Chapter 9.5.1, section reworded</p> <p>Chapter 4.1, section reworded and added information regarding serious incidents</p>	22.02.2022
2.9	2.8	<p>Document name changed</p> <p>Total page inserted in footer and revision increased</p> <p>EC Declaration of Conformity removed</p> <p>Chapter 1.2, reference to exact guideline removed</p> <p>Chapter 14.1, reference to exact guideline removed</p> <p>Chapter 5, table-layout and base UDI-DI, class and Buffer battery inserted</p> <p>Chapter 8.1, red graphics frames formatted</p> <p>Chapter 8.1.1, symbol inserted, font changed to bold</p> <p>Chapter 9.6, Info about Login inserted</p>	